



**DC COMPONENTS CO., LTD.**

RECTIFIER SPECIALISTS

**1N4933G  
THRU  
1N4937G**

**TECHNICAL SPECIFICATIONS OF FAST RECOVERY GLASS PASSIVATED RECTIFIER**

VOLTAGE RANGE - 50 to 600 Volts

CURRENT - 1.0 Ampere

**FEATURES**

- \* High reliability
- \* Low leakage
- \* Low forward voltage drop
- \* High switching capability
- \* Glass passivated junction

**MECHANICAL DATA**

- \* Case: Molded plastic
- \* Epoxy: UL 94V-0 rate flame retardant
- \* Lead: MIL-STD-202E, Method 208 guaranteed
- \* Polarity: Color band denotes cathode end
- \* Mounting position: Any
- \* Weight: 0.35 gram

**MAXIMUM RATINGS AND ELECTRICAL CHARACTERISTICS**

Ratings at 25 °C ambient temperature unless otherwise specified.  
Single phase, half wave, 60 Hz, resistive or inductive load.  
For capacitive load, derate current by 20%.



DO-41

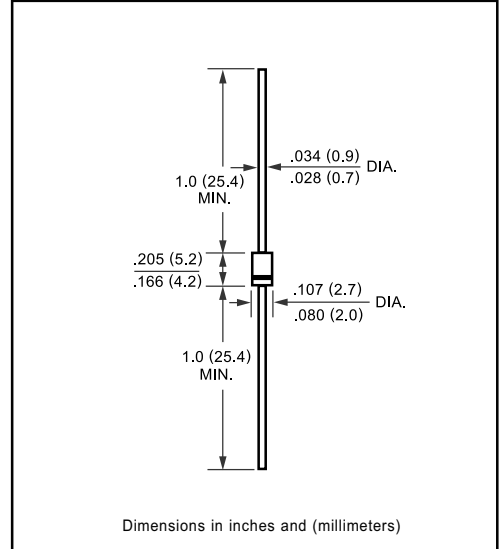

	SYMBOL	1N4933G	1N4934G	1N4935G	1N4936G	1N4937G	UNITS
Maximum Recurrent Peak Reverse Voltage	V <sub>RRM</sub>	50	100	200	400	600	Volts
Maximum RMS Voltage	V <sub>RMS</sub>	35	70	140	280	420	Volts
Maximum DC Blocking Voltage	V <sub>DC</sub>	50	100	200	400	600	Volts
Maximum Average Forward Rectified Current at T <sub>A</sub> = 55°C	I <sub>O</sub>	1.0					Amps
Peak Forward Surge Current 8.3 ms single half sine-wave superimposed on rated load (JEDEC Method)	I <sub>FSM</sub>	30					Amps
Maximum Instantaneous Forward Voltage at 1.0A DC	V <sub>F</sub>	1.3					Volts
Maximum DC Reverse Current at Rated DC Blocking Voltage T <sub>A</sub> = 25°C	I <sub>R</sub>	5.0					uAmps
Maximum Full Load Reverse Current Full Cycle Average, .375"(9.5mm) lead length at T <sub>L</sub> = 55°C		100					uAmps
Maximum Reverse Recovery Time (Note 1)	t <sub>rr</sub>	150			250		nSec
Typical Junction Capacitance (Note 2)	C <sub>J</sub>	15					pF
Operating and Storage Temperature Range	T <sub>J</sub> , T <sub>STG</sub>	-65 to + 150					°C

NOTES : 1. Test Conditions: I<sub>F</sub> = 0.5A, I<sub>R</sub>=1.0A, I<sub>RR</sub>=0.25A  
2. Measured at 1 MHz and applied reverse voltage of 4.0 volts

# RATING AND CHARACTERISTIC CURVES ( 1N4933G THRU 1N4937G )

FIG. 1 - TEST CIRCUIT DIAGRAM AND REVERSE RECOVERY TIME CHARACTERISTIC

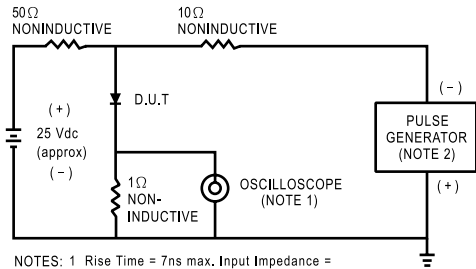

NOTES: 1 Rise Time = 7ns max. Input Impedance = 1 megohm. 22pF.  
 2. Rise Time = 10ns max. Source Impedance = 50 ohms.

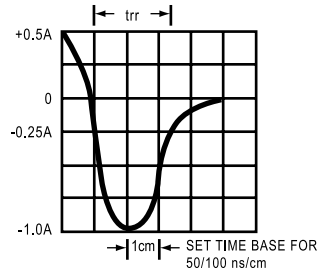

FIG. 1 - TYPICAL FORWARD CURRENT DERATING CURVE

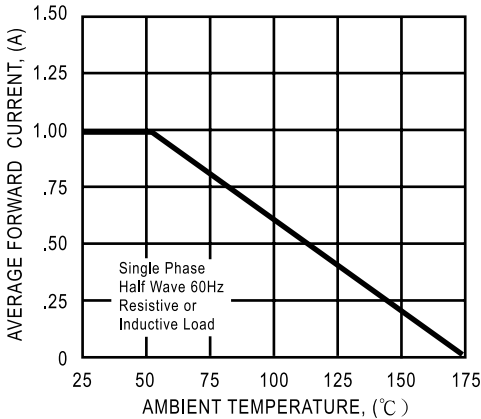

FIG. 3 - TYPICAL INSTANTANEOUS FORWARD CHARACTERISTICS

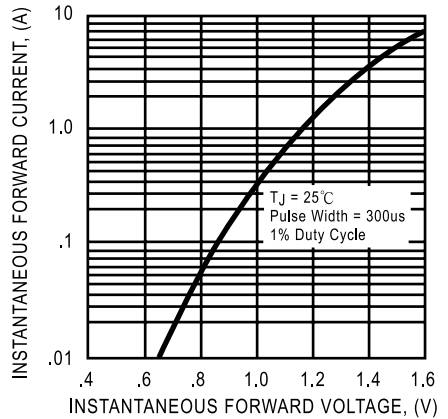

FIG. 4 - TYPICAL JUNCTION CAPACITANCE

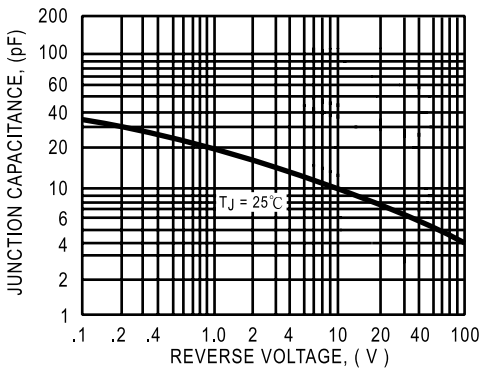
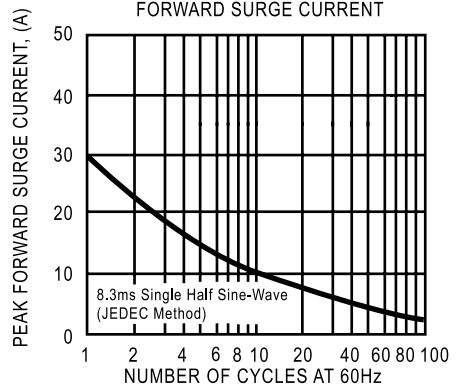

FIG. 3 - MAXIMUM NON-REPETITIVE FORWARD SURGE CURRENT



DC COMPONENTS CO., LTD.