

10 Gbits/s Lithium Niobate Electro-Optic Modulator



The Lithium Niobate Modulators include three single-drive modulators (2623N, 2623Y, 2623CS) and a single-drive modulator with an integrated attenuator (2623CSA). All devices are capable of modulation rates up to 10 Gbits/s.

Features

- Ti-diffusion process
- Single-drive technology
- C- and L-band models
- Slim, hermetic package
- Bandwidths up to 10 GHz
- Operational over a temperature range of 0 °C to 70 °C
- 43 Ω design for minimal electrical reflections
- Angled interfaces for minimal optical reflections
- Integrated optical attenuator available on 10 Gbits/s modulator (2623CSA)
- Tested to *Telcordia Technologies** 468

Benefits

- Excellent long-term bias stability
- Internal polarizer
- Low modulation voltages

Applications

- Digital high-speed telecommunications:
 - SONET: OC-1 through OC-192
 - SDH: STM-16, STM-64
 - Undersea communications
- Internet data communications
- SONET/SDH test equipment

* *Telcordia Technologies* is a trademark of Telcordia Technologies, Inc.

Description

The 10 Gbits/s Electro-Optic Modulator is designed for long-wavelength, single-mode external amplitude modulation applications. It uses an integrated Mach-Zehnder configuration to convert single polarization CW light from a semiconductor (DFB) laser into a time-varying optical output signal. Agere Systems Inc. also offers a 10 mW CW laser with polarization-maintaining fiber (D2525P) to use as a source for the modulator.

The Ti-diffusion process is a standard feature on all modulator devices. The 2623N, 2623Y, and 2623CS are single-drive, 10 Gbits/s modulators; the 2623CSA

is a single-drive, 10 Gbits/s modulator with an attenuating section. Variable attenuation to >19 dB is achieved through a dc bias voltage.

The package is hermetic to protect the LiNbO₃ die from the environment. Novel processing techniques now make it possible to achieve 20-year operation with little drift in the dc bias point. The modulator is tested to, and meets the intent of TR-NWT-00468.

Other standard features include PANDA-type polarization-maintaining fiber (PMF) for the optical input (all codes) and output (2623N, 2623Y, and 2623C) fiber with FC-type connectors that are keyed to the axis of polarization. Custom designs are available.

Absolute Maximum Ratings

Stresses in excess of the absolute maximum ratings can cause permanent damage to the device. These are absolute stress ratings only. Functional operation of the device is not implied at these or any other conditions in excess of those given in the operational sections of the data sheet. Exposure to absolute maximum ratings for extended periods can adversely affect device reliability.

Parameter	Symbol	Min	Max	Unit
Storage Temperature	T _{stg}	-40	85	°C
Optical Input Power @ 1.5 μm	P _{IN}	—	30	mW
RF Voltage (peak to peak)	V _{RF}	—	10	V
dc Voltage (RF input)	V _{dcRF}	-20	20	V
dc Voltage (Attenuator input)	V _{dcATT}	-25	25	V
Operating Temperature	T _{OP}	0	70	°C

Optical/Electrical Characteristics

Table 1. Optical/Electrical Characteristics

Parameter	Min	Typ	Max	Unit
Operating Wavelength:				
C-band	1525	—	1565	nm
L-band	1565	—	1620	nm
Insertion Loss:				
2623N, 2623Y, 2623CS	3	3.7	5.5	dB
2623CSA	3.5	4.5	6.5	dB
Extinction Ratio @ dc	20	27	—	dB
Extinction Ratio @ RF	—	13	—	dB
S11 Optical Return Loss	—	—	-35	dB
Bandwidth*	8	10	—	GHz
Drive Voltage ($V\pi$) @ dc	2.8	3.1	4.0	V
Drive Voltage ($V\pi$) @ 1 GHz	3.5	4.1	5.0	V
Attenuation Voltage @ -19 dB	15	19	22	V
Electrode Impedance	—	43	—	Ω
S11 Electrical Return Loss (0.13 GHz—5 GHz)	—	-15	-13	dB
S11 Electrical Return Loss (5 GHz—10 GHz)	—	-14	-12	dB
S11 Electrical Return Loss (10 GHz—18 GHz)	—	-8	-6	dB

* Bandwidth stated is electrical-optical-electrical as determined by the ratio of the received RF electrical power (at a photodiode) relative to the RF electrical power used to drive the modulator. This response is referenced to the value at 130 MHz.

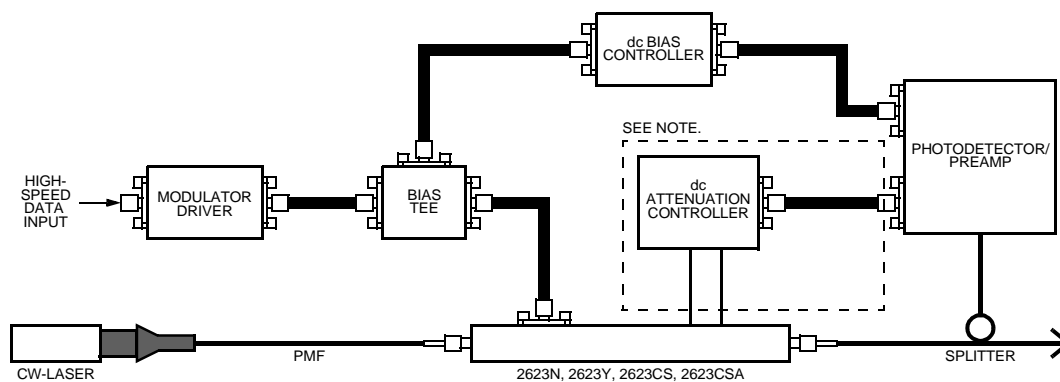

Note: Circuitry in dotted lines is used only with the 2623CSA.

1-1062 (F)

Figure 1. Recommended Operating Circuit Diagram

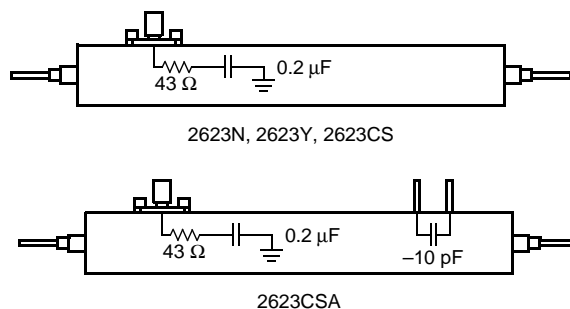

Figure 2. Equivalent Circuit Diagram

1-1063 (F)

Optical/Electrical Characteristics (continued)

Electrical Signal Input

Electrical signal input is made through SMA coaxial connectors. The standard device includes an internal termination network. Care must be taken not to exceed the recommended 8 in./lb. of torque when making connections to these inputs. High-frequency coaxial cable is recommended.

Characteristic Curves

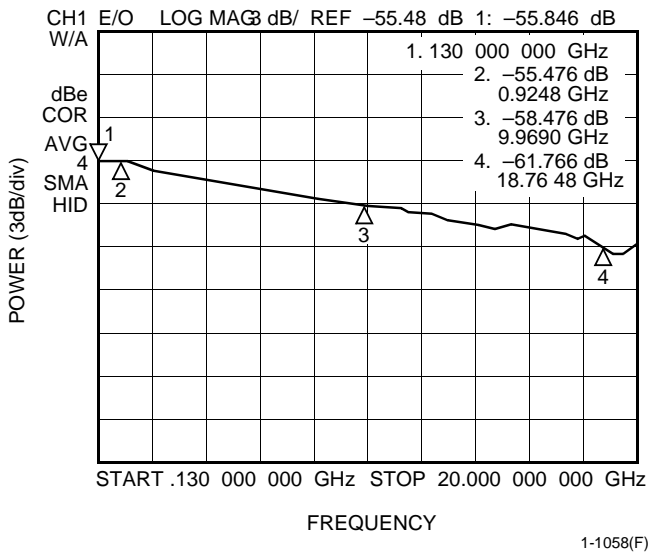

Figure 3. Magnitude of Electro-Optic Response, 0.130 GHz—20 GHz.

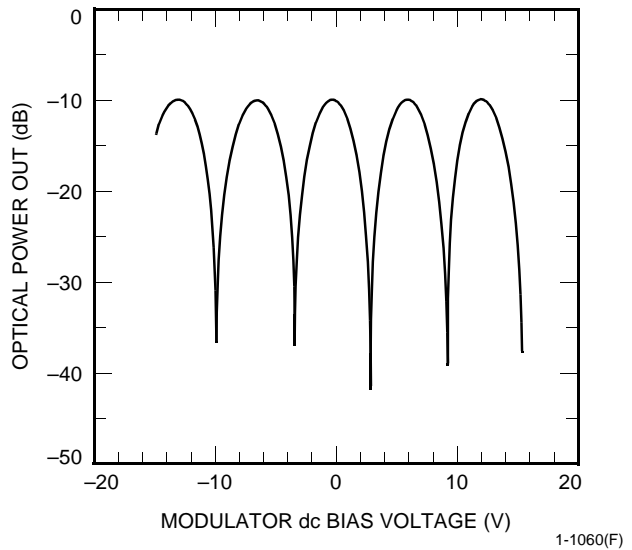

Figure 5. Output Power vs. Bias Voltage

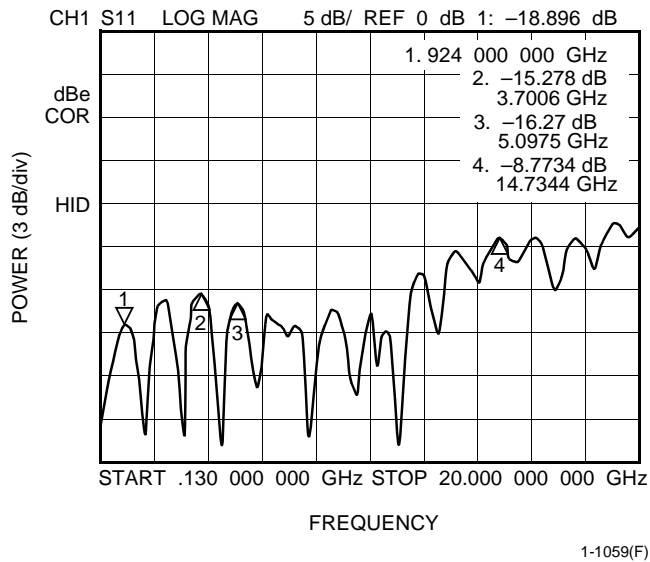

Figure 4. S11, 0.130 GHz—20 GHz

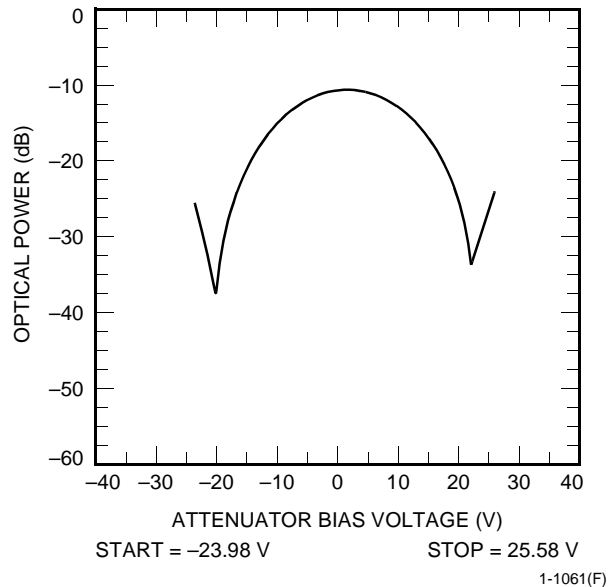
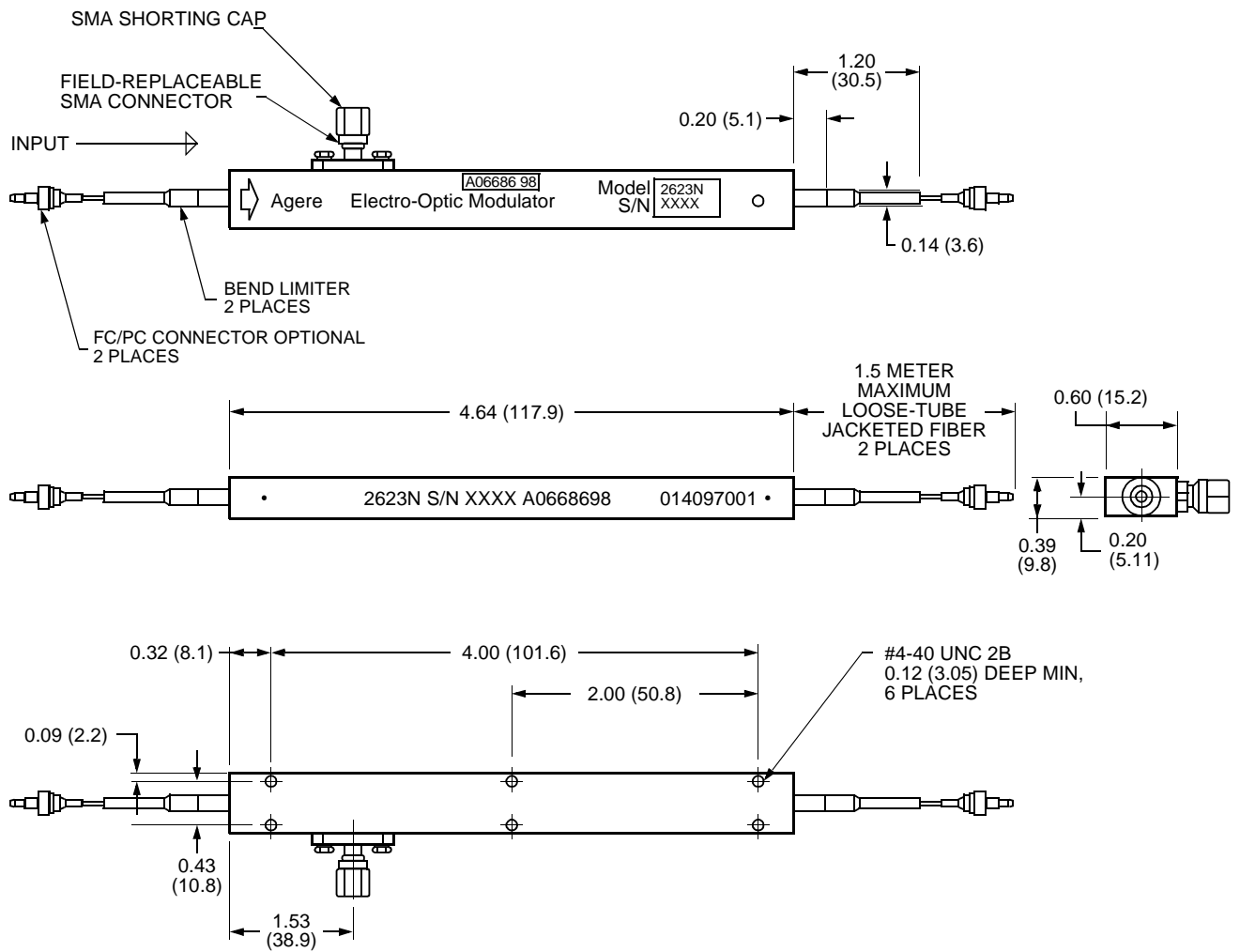

Figure 6. Optical Power vs. Attenuator Bias Voltage

Outline Diagrams

Dimensions are in inches and (millimeters).

2623N, 2623Y, 2623CS Lithium Niobate Modulators



1-1064(F)a

Outline Diagrams (continued)

2623CSA Lithium Niobate Modulator

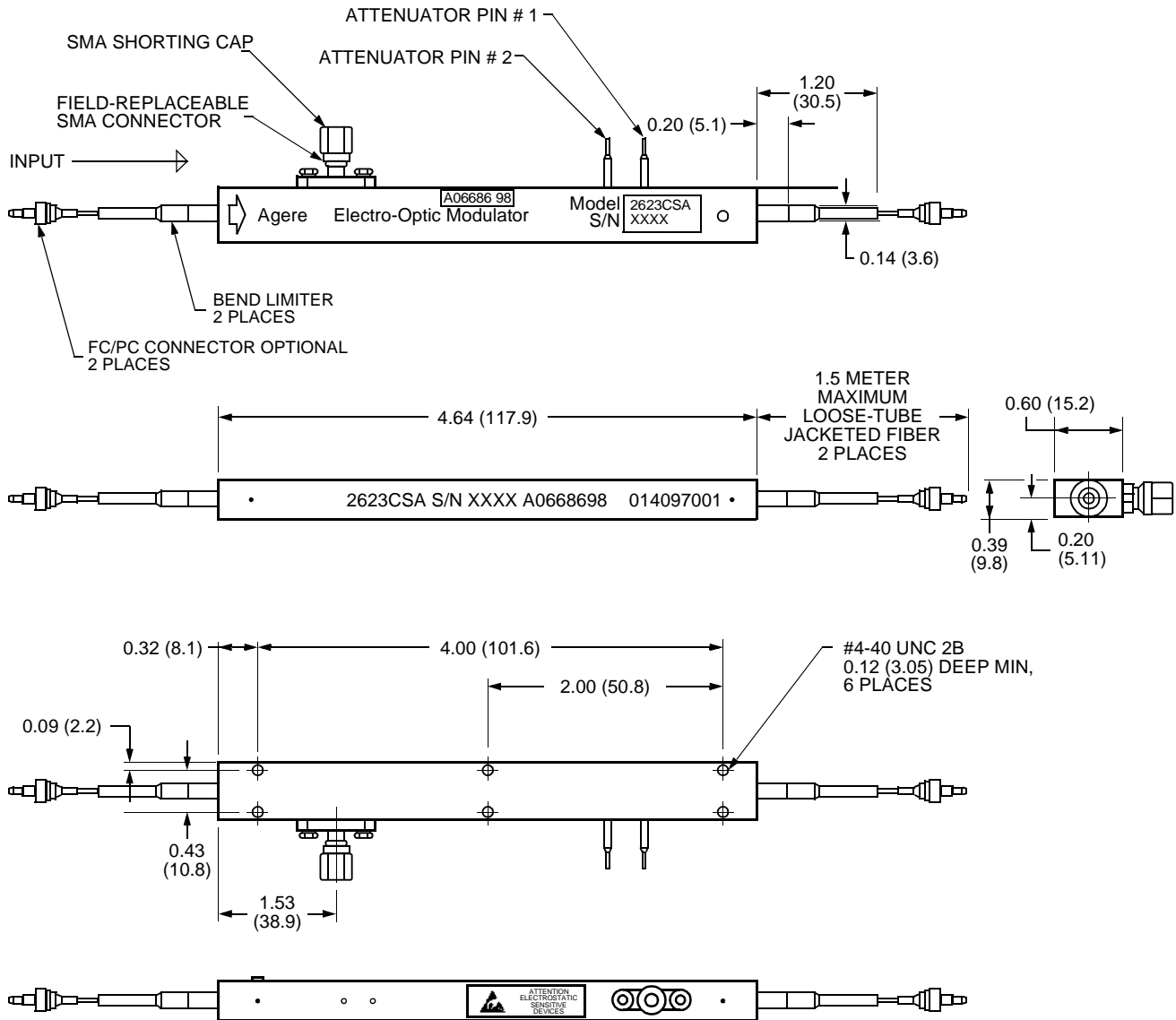

1-1064F.c

Package Information

Designed to NEBS (inside plant) standards, the hermetic package design incorporates a laser-sealed lid and soldered fibers. The minimum bend radius for the fiber is 1.5 in. To prevent warping, use only the two center screws to mount the device.

Table 2. Package Information

Description	Type
Input Optical Fiber (all codes)	PANDA-type PMF
Output Optical Fiber: 2623N, 2623Y, 2623CS 2623CSA	PANDA-type PMF Standard Single-mode
Fiber Connector	FC
Fiber Length	1.5 m max
RF Connector	SMA
Package Dimensions	See Outline Drawings, page 5, 6.

Ordering Information

Table 3. Device Information

Part Number	Minimum Bandwidth (GHz)	Attenuator	C-Band	L-Band	Comcode
2623N	8	No	Yes	Yes	1077393100
2623Y	9	No	Yes	Yes	108864604
2623CS	10	No	Yes	Yes	107862823
2623CSA	8	Yes	Yes	Yes	108433954

For additional information, contact your Agere Systems Account Manager or the following:

INTERNET: <http://www.agere.com>

E-MAIL: docmaster@micro.lucent.com

N. AMERICA: Agere Systems Inc., 555 Union Boulevard, Room 30L-15P-BA, Allentown, PA 18109-3286
1-800-372-2447, FAX 610-712-4106 (In CANADA: **1-800-553-2448**, FAX 610-712-4106)

ASIA PACIFIC: Agere Systems Singapore Pte. Ltd., 77 Science Park Drive, #03-18 Cintech III, Singapore 118256
Tel. (65) 778 8833, FAX (65) 777 7495

CHINA: Agere Systems (Shanghai) Co., Ltd., 33/F Jin Mao Tower, 88 Century Boulevard Pudong, Shanghai 200121 PRC
Tel. (86) 21 50471212, FAX (86) 21 50472266

JAPAN: Agere Systems Japan Ltd., 7-18, Higashi-Gotanda 2-chome, Shinagawa-ku, Tokyo 141, Japan
Tel. (81) 3 5421 1600, FAX (81) 3 5421 1700

EUROPE: Data Requests: DATALINE: **Tel. (44) 7000 582 368**, FAX (44) 1189 328 148
Technical Inquiries: OPTOELECTRONICS MARKETING: **(44) 1344 865 900** (Ascot UK)

Agere Systems Inc. reserves the right to make changes to the product(s) or information contained herein without notice. No liability is assumed as a result of their use or application.

Copyright © 2001 Agere Systems Inc.
All Rights Reserved

May 2001
DS00-331OPTO-2 (Replaces DS00-331OPTO-1)

