

1SMB5913A - 1SMB5957A

SILICON ZENER DIODES

V_Z : 3.3 - 240 Volts
P_D : 1.5 Watts

FEATURES :

- * Complete Voltage Range 3.3 to 200 Volts
- * High peak reverse power dissipation
- * High reliability
- * Low leakage current

MECHANICAL DATA

- * Case : SMB (DO-214AA) Molded plastic
- * Epoxy : UL94V-O rate flame retardant
- * Lead : Lead formed for Surface mount
- * Polarity : Color band denotes cathode end
- * Mounting position : Any
- * Weight : 0.093 gram

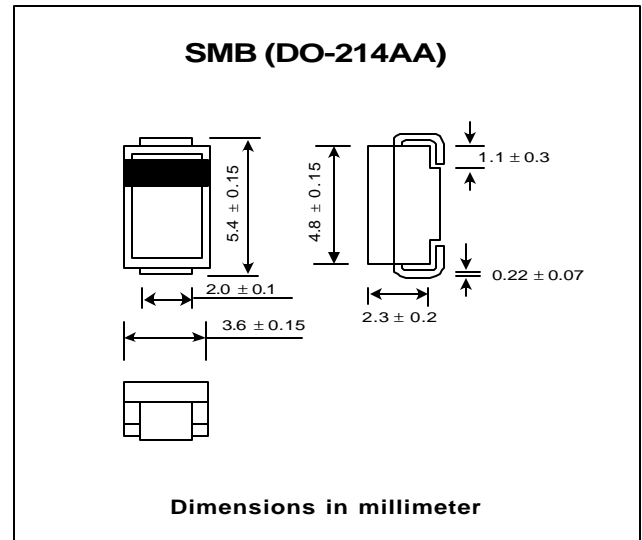

MAXIMUM RATINGS

Rating at 25 °C ambient temperature unless otherwise specified

Rating	Symbol	Value	Unit
DC Power Dissipation at T _L = 75 °C (Note1)	P _D	1.5	Watts
Maximum Forward Voltage at I _F = 200 mA	V _F	1.5	Volts
Junction Temperature Range	T _J	- 55 to + 150	°C
Storage Temperature Range	T _s	- 55 to + 150	°C

Note :

(1) T_L = Lead temperature at 5.0 mm² (0.013 mm thick) copper land areas.

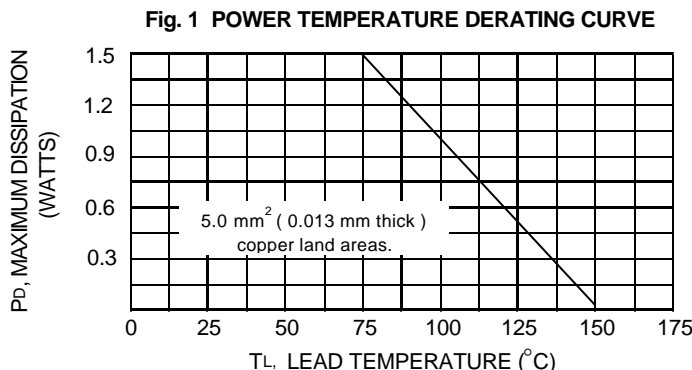



Certificate Number: Q9004



Certificate Number: E1725

ELECTRICAL CHARACTERISTICS

Rating at = 25 °C ambient temperature unless otherwise specified

TYPE	Nominal Zener Voltage		Maximum Zener Impedance			Maximum Reverse Leakage Current		Maximum DC Zener Current
	V _Z @ I _{ZT}	I _{ZT}	Z _{ZT} @ I _{ZT}	Z _{ZK} @ I _{ZK}	I _{ZK}	I _R @ V _R		I _{ZM}
	(V)	(mA)	(Ω)	(Ω)	(mA)	(μA)	(V)	(mA)
1SMB5913A	3.3	113.6	10	500	1.0	100	1.0	454
1SMB5914A	3.6	104.2	9.0	500	1.0	75	1.0	416
1SMB5915A	3.9	96.1	7.5	500	1.0	25	1.0	384
1SMB5916A	4.3	87.2	6.0	500	1.0	5.0	1.0	348
1SMB5917A	4.7	79.8	5.0	500	1.0	5.0	1.5	319
1SMB5918A	5.1	73.5	4.0	500	1.0	5.0	2.0	294
1SMB5919A	5.6	66.9	2.0	250	1.0	5.0	3.0	267
1SMB5920A	6.2	60.5	2.0	200	1.0	5.0	4.0	241
1SMB5921A	6.8	55.1	2.5	200	1.0	50	5.2	220
1SMB5922A	7.5	50.0	3.0	400	0.5	50	6.0	200
1SMB5923A	8.2	45.7	3.5	400	0.5	50	6.5	182
1SMB5924A	9.1	41.2	4.0	500	0.5	50	7.0	164
1SMB5925A	10	37.5	4.5	500	0.25	50	8.0	150
1SMB5926A	11	34.1	5.5	550	0.25	50	8.4	136
1SMB5927A	12	31.2	6.5	550	0.25	1.0	9.1	125
1SMB5928A	13	28.8	7.0	550	0.25	1.0	9.9	115
1SMB5929A	15	25.0	9.0	600	0.25	1.0	11.4	100
1SMB5930A	16	23.4	10	600	0.25	1.0	12.2	93
1SMB5931A	18	20.8	12	650	0.25	1.0	13.7	83
1SMB5932A	20	18.7	14	650	0.25	1.0	15.2	75
1SMB5933A	22	17.0	17.5	650	0.25	1.0	16.7	68
1SMB5934A	24	15.6	19	700	0.25	1.0	18.2	62
1SMB5935A	27	13.9	23	700	0.25	1.0	20.6	55
1SMB5936A	30	12.5	26	750	0.25	1.0	22.8	50
1SMB5937A	33	11.4	33	800	0.25	1.0	25.1	45
1SMB5938A	36	10.4	38	850	0.25	1.0	27.4	41
1SMB5939A	39	9.6	45	900	0.25	1.0	29.7	38
1SMB5940A	43	8.7	53	950	0.25	1.0	32.7	34
1SMB5941A	47	8.0	67	1000	0.25	1.0	35.8	31
1SMB5942A	51	7.3	70	1100	0.25	1.0	38.8	29
1SMB5943A	56	6.7	86	1300	0.25	1.0	42.6	26
1SMB5944A	62	6.0	100	1500	0.25	1.0	47.1	24
1SMB5945A	68	5.5	120	1700	0.25	1.0	51.7	22
1SMB5946A	75	5.0	140	2000	0.25	1.0	56.0	20
1SMB5947A	82	4.6	160	2500	0.25	1.0	62.2	18
1SMB5948A	91	4.1	200	3000	0.25	1.0	69.2	16
1SMB5949A	100	3.7	250	3100	0.25	1.0	76.0	15
1SMB5950A	110	3.4	300	4000	0.25	1.0	83.6	13
1SMB5951A	120	3.1	380	4500	0.25	1.0	91.2	12
1SMB5952A	130	2.9	450	5000	0.25	1.0	98.8	11
1SMB5953A	150	2.5	600	6000	0.25	1.0	114.0	10
1SMB5954A	160	2.3	700	6500	0.25	1.0	121.6	9.0
1SMB5955A	180	2.1	900	7000	0.25	1.0	136.8	8.0
1SMB5956A	200	1.9	1200	8000	0.25	1.0	152.0	7.0
1SMB5957A	240	1.5	1600	9000	0.25	1.0	182.4	6.0

Note :

(1) Suffix " A " indicates ± 10% tolerance, suffix " B " indicates ± 5.0% tolerance.