

N-CHANNEL ENHANCEMENT MODE FIELD EFFECT TRANSISTOR

VOLTAGE 60 Volts

CURRENT 115 mAmp

PACKAGE SOT-23

DESCRIPTION

• N-channel enhancement mode field effect transistor, designed for high speed pulsed amplifier and driver applications, which is manufactured by the N-Channel DMOS process.

FEATURES

- High density cell design for low $R_{DS(ON)}$.
- Voltage controlled small signal switching.
- Rugged and reliable.
- High saturation current capability.
- High-speed switching.
- CMOS logic compatible input.
- Not thermal runaway.
- No secondary breakdown.

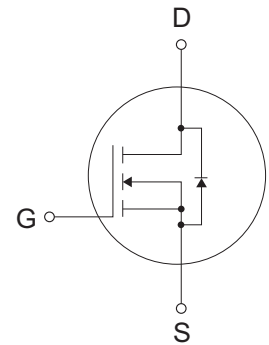
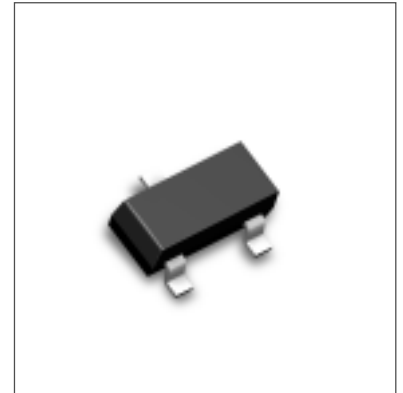

ABSOLUTE MAXIMUM RATINGS

$T_A = 25^\circ\text{C}$ Unless otherwise noted.

Parameter	Symbol	2N7002	Units
Drain-Source Voltage	V_{DSS}	60	V
Drain-Gate Voltage ($R_{gs} \leq 1\text{M}\Omega$)	V_{DRG}	60	V
Gate Source Voltage -Continuous -No Repetitive ($t_p < 50\mu\text{s}$)	V_{GSS}	± 20 ± 20	V
Maximum Drain Current -Continuous -Pulsed	I_D	115 800	mA
Maximum POver Dissipation Derated Above 25°C	P_D	200	mW
Operation and Storage Temperature Range	T_J, T_{STG}	-55 to +150	$^\circ\text{C}$
Thermal Resistance, Junction-to-Ambient	$R_{\theta JA}$	625	$^\circ\text{C} / \text{W}$

ELECTRICAL CHARACTERISTICS

T_A = 25°C Unless otherwise noted.

Parameter	Symbol	Conditions	Min.	Typ.	Max.	Units
OFF CHARACTERISTICS						
Drain-Source Breakdown Voltage	BV _{DSS}	V _{GS} =0V, I _b =10μA	60	-	-	V
Zero Gate Voltage Drain Current	I _{DSS}	V _{DS} =60V, V _{GS} =0V, T _J =25°C V _{DS} =60V, V _{GS} =0V, T _J =125°C	- -	- -	1.0 0.5	μA mA
Gate - Body Leakage, Forward	I _{GSSF}	V _{DS} =0V, V _{GS} =20V	-	-	100	nA
Gate - Body Leakage, Reverse	I _{GSSR}	V _{DS} =0V, V _{GS} = -20V	-	-	-100	nA
ON CHARACTERISTICS (note1)						
Gate Threshold Voltage	V _{GS(th)}	V _{DS} =V _{GS} , I _b =250μA	1	2.1	2.5	V
Static Drain-Source On-Resistance	R _{DS(on)}	V _{GS} =10V, I _b =500mA, T _J =100°C	-	1.2	7.5	Ω
Drain-Source On-Voltage	V _{DS(on)}	V _{GS} =10V, I _b =500mA V _{GS} =5.0V, I _b =50mA	- -	0.60 0.09	3.75 1.50	V
On-State Drain Current	I _{D(on)}	V _{GS} =10V, V _{DS} ≥ 2V _{DS(on)}	500	2700	-	mA
Forward Transconductance	G _{FS}	V _{DS} ≥ 2V _{DS(on)} , I _b =200mA	80	320	-	mS
DYNAMIC CHARACTERISTICS						
Input Capacitance	C _{ISS}	V _{DS} =25V, V _{GS} =0V, F=1.0 MHz	-	20	50	pF
Output Capacitance	C _{OSS}	V _{DS} =25V, V _{GS} =0V, F=1.0 MHz	-	11	25	pF
Reverse Transfer Capacitance	C _{RSS}	V _{DS} =25V, V _{GS} =0V, F=1.0 MHz	-	4	5	pF
Turn-On Time	T _{ON}	V _{DD} =30V, R _L =150Ω, I _b =200 mA V _{GS} =10V, R _{GEN} =25Ω	-	-	20	ns
Turn-Off Time	T _{OFF}	V _{DD} =30V, R _L =150Ω, I _b =200 mA V _{GS} =10V, R _{GEN} =25Ω	-	-	20	ns

Note:

1.Pulse Test: Pulse Width ≤ 300μs, Duty Cycle ≤ 2.0%

RATING and CHARACTERISTIC CURVES

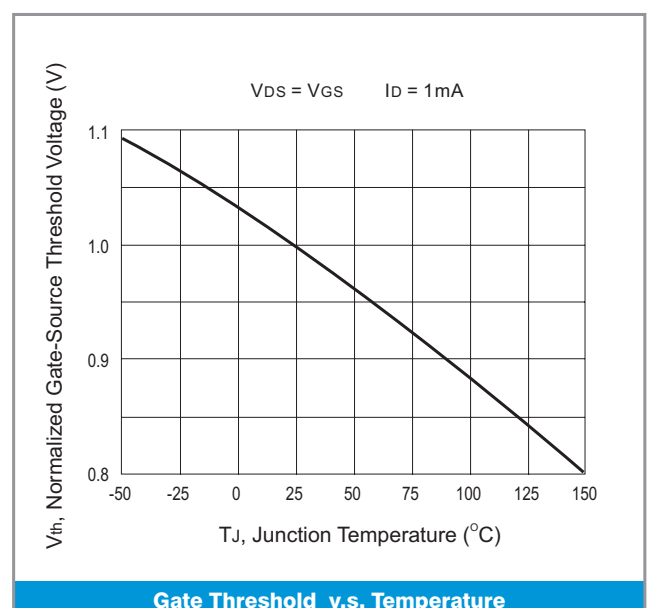
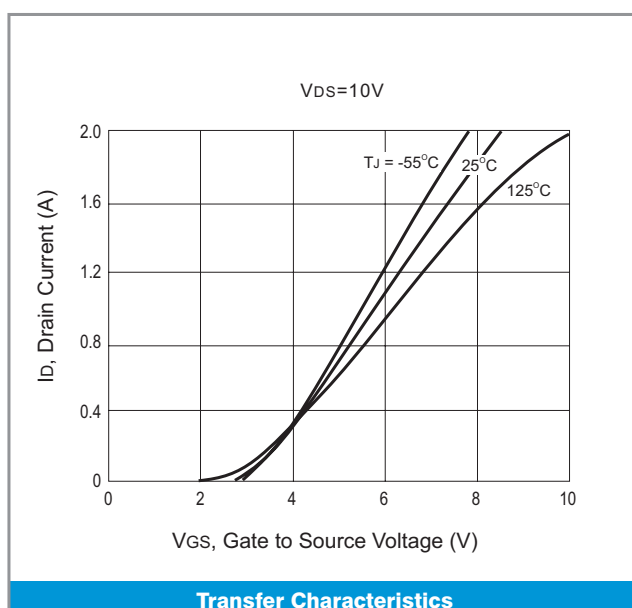
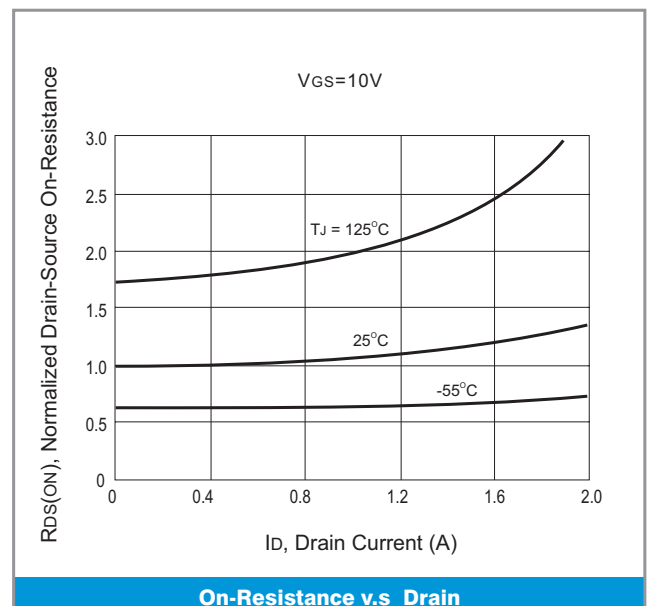
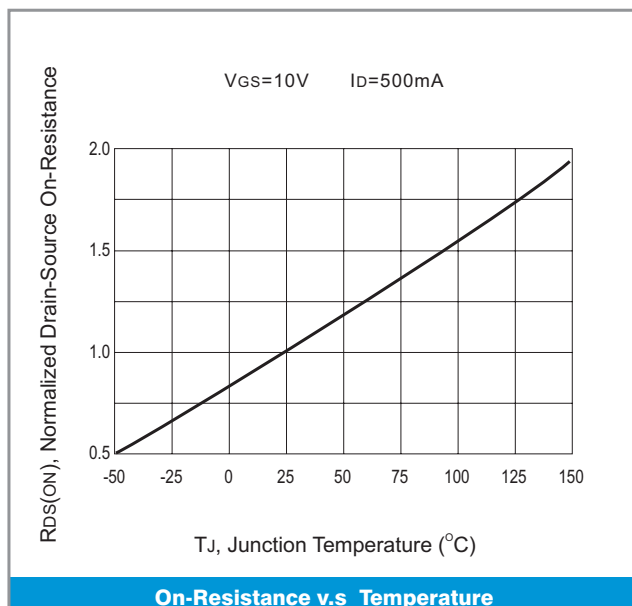
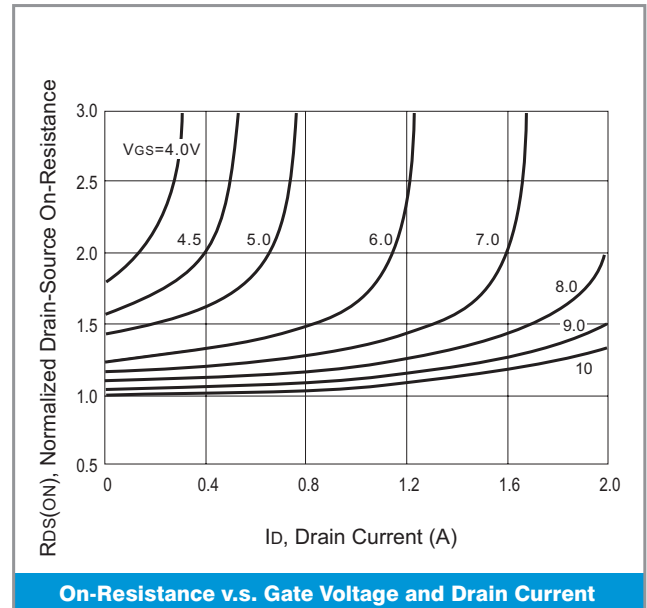
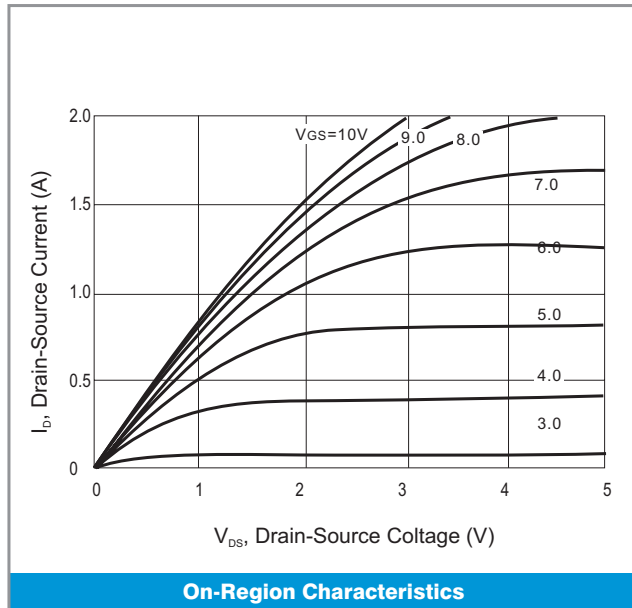

RATING and CHARACTERISTIC CURVES

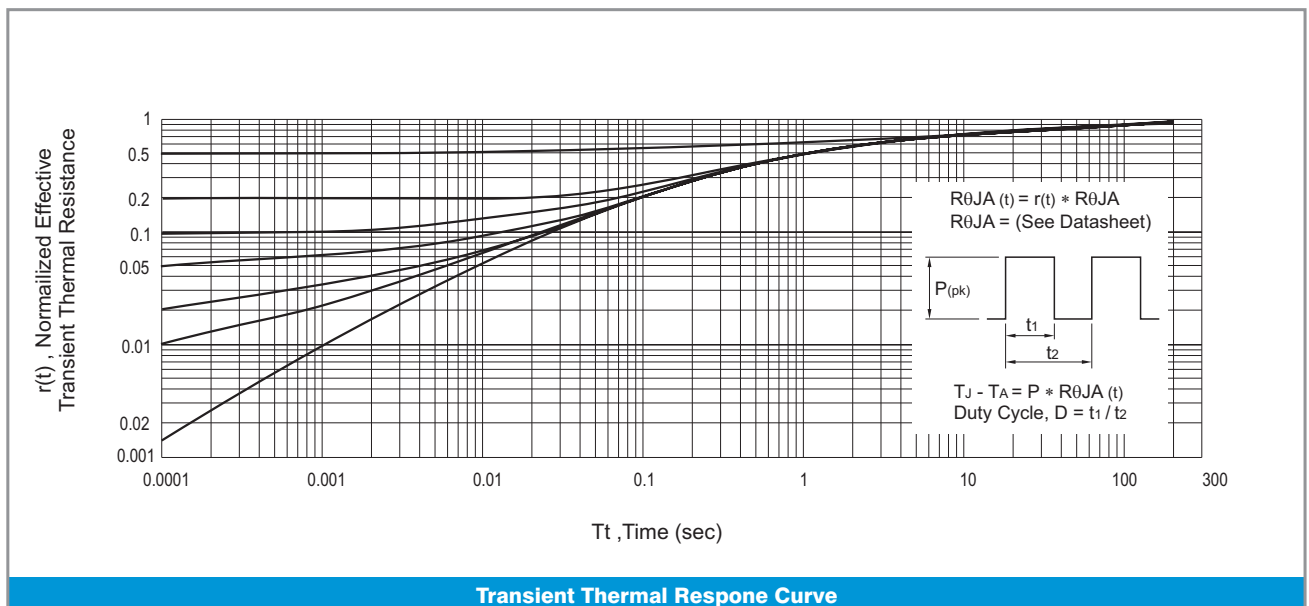
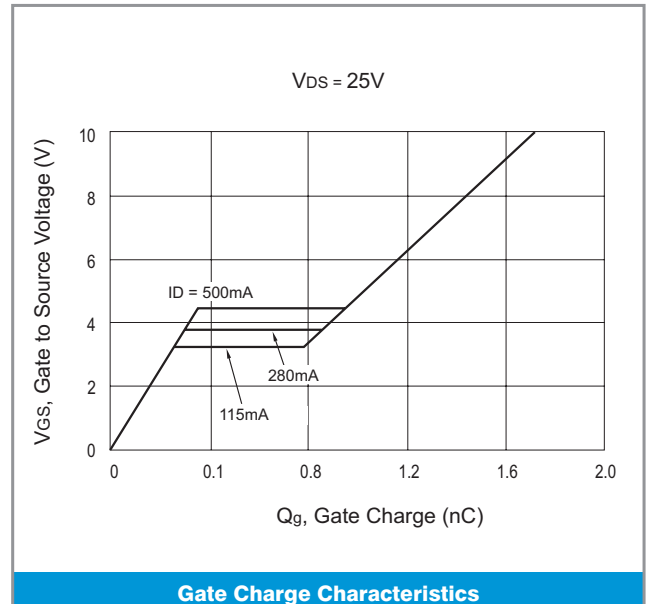
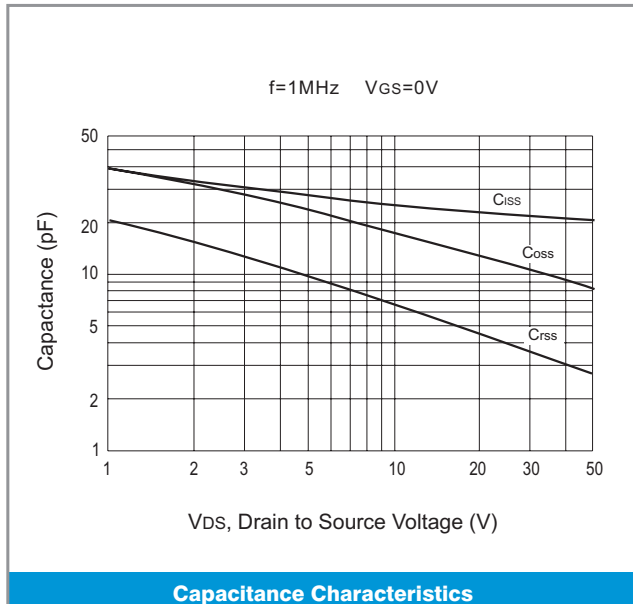
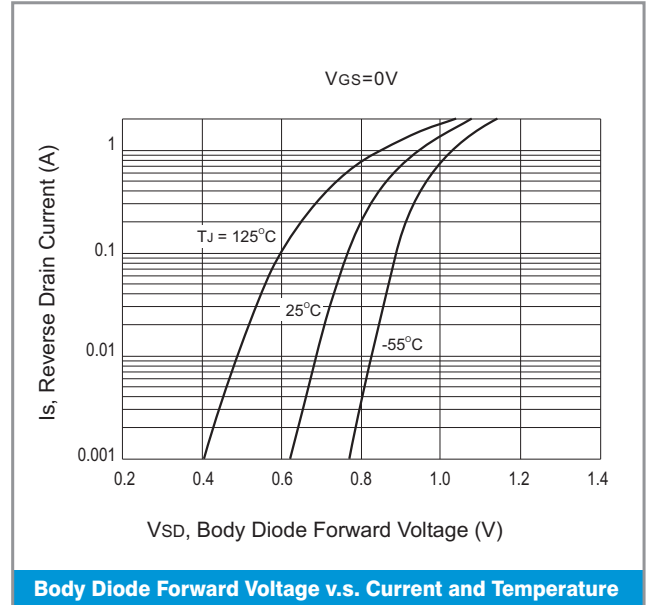
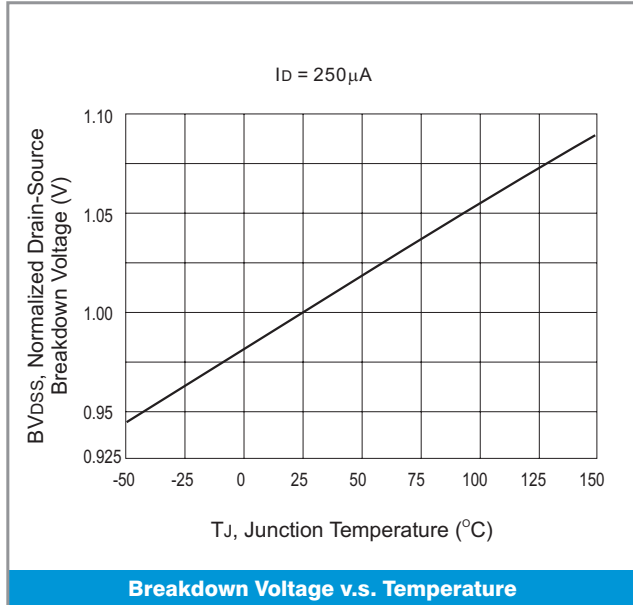

RATING and CHARACTERISTIC CURVES

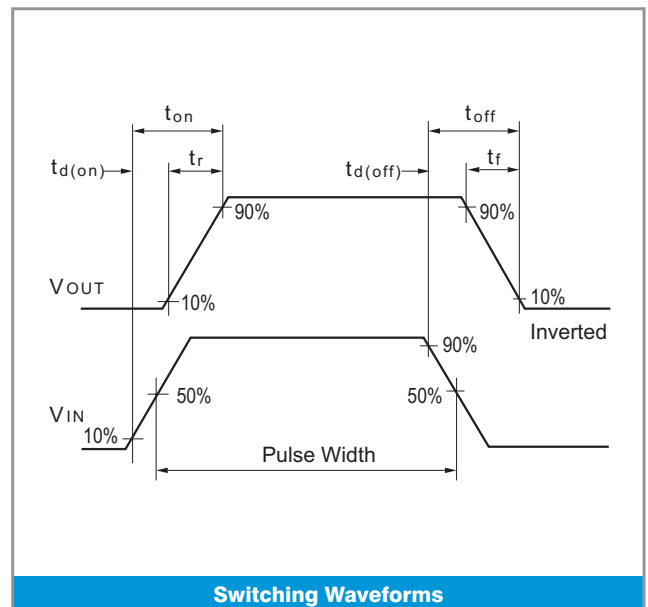
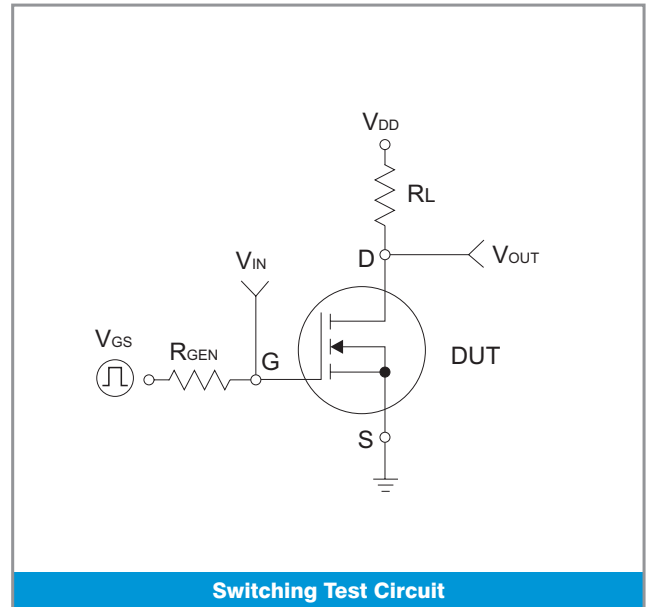
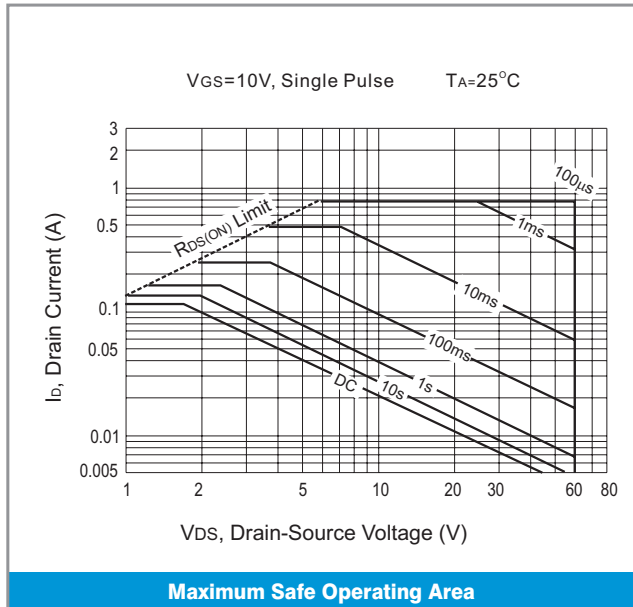

SOT-23

