

MOTOROLA SEMICONDUCTOR TECHNICAL DATA

**NPN
2N5989
2N5991**

**HIGH POWER PLASTIC
COMPLEMENTARY SILICON POWER TRANSISTORS**

... designed for use in general-purpose amplifier and switching circuits.

- Collector-Base Voltage — $V_{CB0} = 60 \text{ Vdc} \text{ — } 2N5989$
 $= 100 \text{ Vdc} \text{ — } 2N5991$
- Collector-Emitter Voltage — $V_{CEO} = 40 \text{ Vdc} \text{ — } 2N5989$
 $= 80 \text{ Vdc} \text{ — } 2N5991$
- DC Current Gain —
 $h_{FE} = 20\text{--}120 @ I_C = 6.0 \text{ Adc}$
 $= 7.0 \text{ (Min)} @ I_C = 12 \text{ Adc}$
- Collector-Emitter Saturation Voltage —
 $V_{CE(sat)} = 0.7 \text{ Vdc (Max)} @ I_C = 6.0 \text{ Adc}$

**12 AMPERE
POWER TRANSISTORS
COMPLEMENTARY SILICON
40, 60, 80 VOLTS
100 WATTS**

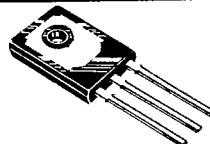

***MAXIMUM RATINGS**

Rating	Symbol	2N5989	2N5991	Unit
Collector-Base Voltage	V_{CB}	60	100	Vdc
Collector-Emitter Voltage	V_{CEO}	40	80	Vdc
Emitter-Base Voltage	V_{EB}	5.0		Vdc
Collector Current — Continuous	I_C	12		Adc
Peak		20		
Base Current	I_B	4.0		Adc
Total Power Dissipation @ $T_C = 25^\circ\text{C}$	P_D	100		Watts
Derate above 25°C		0.8		W/ $^\circ\text{C}$
Operating and Storage Junction Temperature Range	T_J, T_{stg}	-65 to +150		$^\circ\text{C}$

THERMAL CHARACTERISTICS

Characteristic	Symbol	Max	Unit
Thermal Resistance, Junction to Case	θ_{JC}	1.25	$^\circ\text{C/W}$

*Indicates JEDEC Registered Data

FIGURE 1 — POWER DERATING

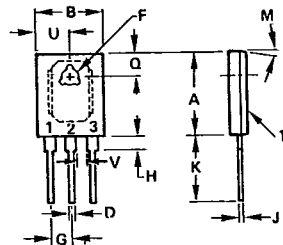
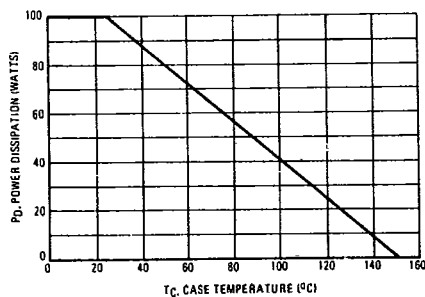

STYLE 2:
PIN 1. EMITTER
2. COLLECTOR
3. BASE

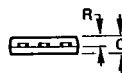

- NOTES:
1. DIM "D" UNCONTROLLED IN ZONE "H"
 2. DIM "F" DIA THRU
 3. HEAT SINK CONTACT AREA (BOTTOM)
 4. LEADS WITHIN 0.005° RAD OF TRUE POSITION (TP) AT MAXIMUM MATERIAL CONDITION.

DIM	MILLIMETERS		INCHES	
	MIN	MAX	MIN	MAX
A	16.13	16.38	0.635	0.645
B	12.57	12.83	0.495	0.505
C	3.18	3.43	0.125	0.135
D	1.09	1.24	0.043	0.049
F	3.51	3.76	0.138	0.148
G	4.22 BSC		0.166 BSC	
H	2.67	2.92	0.105	0.115
J	0.813	0.864	0.032	0.034
K	15.11	16.38	0.595	0.645
M	90 TYP		90 TYP	
Q	4.70	4.95	0.185	0.195
R	1.91	2.16	0.075	0.085
U	6.22	6.48	0.245	0.255
V	2.03	-	0.080	-

**CASE 90-05
TO-225AB TYPE
(TO-127 TYPE)**

3

*ELECTRICAL CHARACTERISTICS (T_C = 25°C unless otherwise noted)

Characteristic	Symbol	Min	Max	Unit
OFF CHARACTERISTICS				
Collector-Emitter Sustaining Voltage (I _C = 0.2 Adc, I _B = 0)	V _{CEO(sus)}	40 80	—	Vdc
Collector Cutoff Current (V _{CE} = 20 Vdc, I _B = 0) (V _{CE} = 40 Vdc, I _B = 0)	I _{CEO}	— —	2.0 2.0	mAcd
Collector Cutoff Current (V _{CE} = 60 Vdc, V _{BE(off)} = 1.5 Vdc) (V _{CE} = 100 Vdc, V _{BE(off)} = 1.5 Vdc) (V _{CE} = 40 Vdc, V _{BE(off)} = 1.5 Vdc, T _C = 125°C) (V _{CE} = 80 Vdc, V _{BE(off)} = 1.5 Vdc, T _C = 125°C)	I _{CEX}	— — — —	200 200 2.0 2.0	μAcd mAcd
Emitter Cutoff Current (V _{BE} = 5.0 Vdc, I _C = 0)	I _{EBO}	—	1.0	mAcd
ON CHARACTERISTICS				
DC Current Gain (I _C = 1.5 Adc, V _{CE} = 2.0 Vdc) (I _C = 6.0 Adc, V _{CE} = 2.0 Vdc) (I _C = 12 Adc, V _{CE} = 2.0 Vdc)	h _{FE}	40 20 7.0	— 120 —	—
Collector-Emitter Saturation Voltage (I _C = 6.0 Adc, I _B = 0.6 Adc) (I _C = 12 Adc, I _B = 1.8 Adc)	V _{CE(sat)}	— —	0.6 1.7	Vdc
Base-Emitter Saturation Voltage (I _C = 12 Adc, I _B = 1.8 Adc)	V _{BE(sat)}	—	2.5	Vdc
Base-Emitter On Voltage (I _C = 6.0 Adc, V _{CE} = 2.0 Vdc)	V _{BE(on)}	—	1.4	Vdc
DYNAMIC CHARACTERISTICS				
Current-Gain — Bandwidth Product (I _C = 0.5 Adc, V _{CE} = 10 Vdc, f _{test} = 1.0 MHz)	f _T	2.0	—	MHz
Output Capacitance (V _{CB} = 10 Vdc, I _E = 0, f = 1.0 MHz)	C _{ob}	—	300	pF
Small-Signal Current Gain (I _C = 2.0 Adc, V _{CE} = 4.0 Vdc, f = 1.0 kHz)	h _{fe}	20	—	—

*Indicates JEDEC Registered Data.

(1) f_T = |h_{fe}| • f_{test}

FIGURE 2 — SWITCHING TIMES TEST CIRCUIT

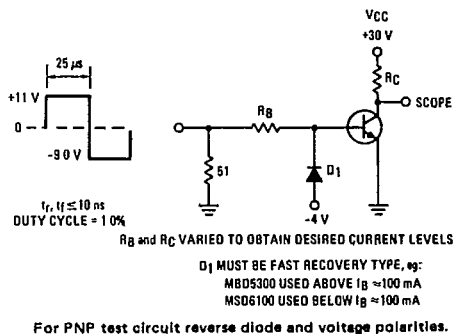

FIGURE 3 — TURN-ON TIME

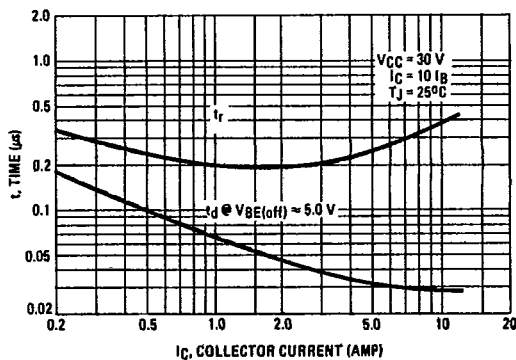

FIGURE 4 - THERMAL RESPONSE

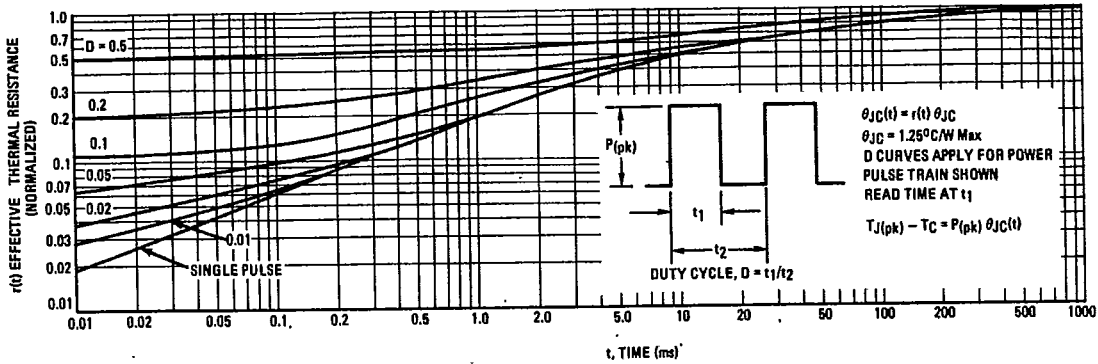
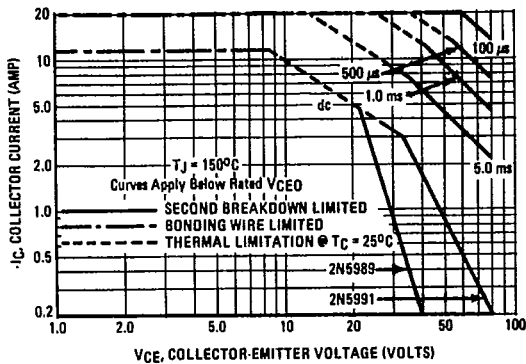

FIGURE 5 - ACTIVE-REGION SAFE OPERATING AREA



There are two limitations on the power handling ability of a transistor: average junction temperature and second breakdown. Safe operating area curves indicate $I_C - V_{CE}$ limits of the transistor that must be observed for reliable operation; i.e., the transistor must not be subjected to greater dissipation than the curves indicate.

The data of Figure 5 is based on $T_{J(pk)} = 150^\circ\text{C}$; T_C is variable depending on conditions. Second breakdown pulse limits are valid for duty cycles to 10% provided $T_{J(pk)} \leq 150^\circ\text{C}$. $T_{J(pk)}$ may be calculated from the data in Figure 4. At high case temperatures, thermal limitations will reduce the power that can be handled to values less than the limitations imposed by second breakdown.

3

FIGURE 6 - TURN-OFF TIME

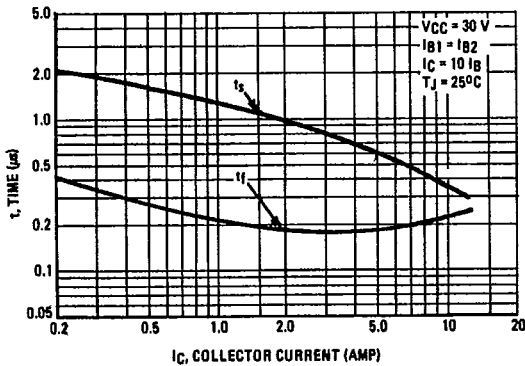

FIGURE 7 - CAPACITANCE

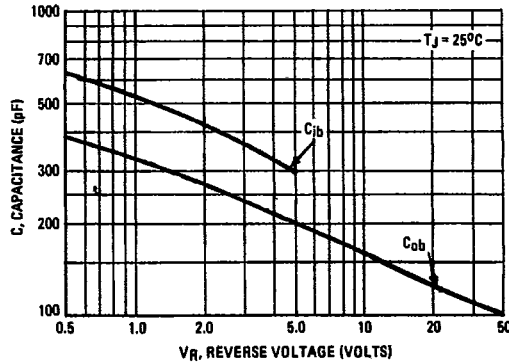

FIGURE 8 - DC CURRENT GAIN

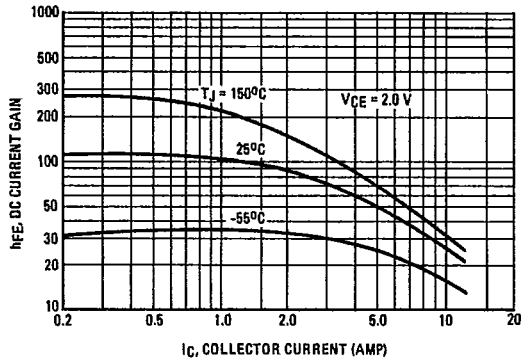

FIGURE 9 - COLLECTOR SATURATION REGION

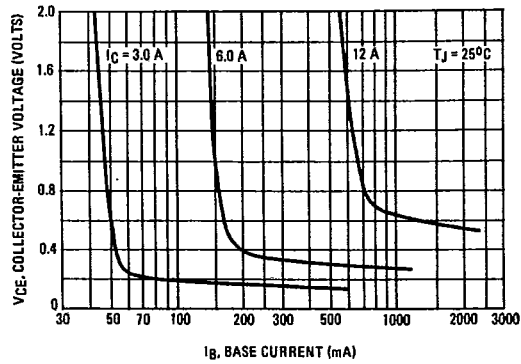
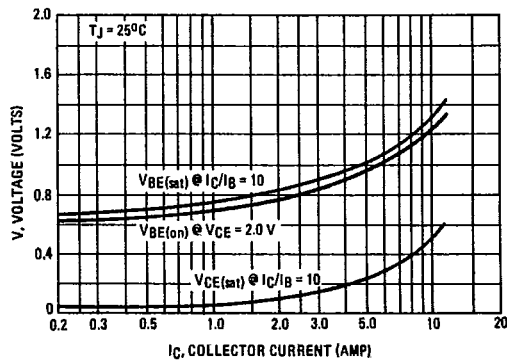

FIGURE 10 - "ON" VOLTAGES



3