

**4A, 60V, 0.600 Ohm, Logic Level,  
N-Channel Power MOSFETs**

The RFD4N06L, RFD4N06LSM are N-Channel enhancement mode silicon gate power field effect transistors specifically designed for use with logic level (5 volt) driving sources in applications such as programmable controllers, automotive switching, and solenoid drivers. This performance is accomplished through a special gate oxide design which provides full rated conduction at gate biases in the 3-5 volt range, thereby facilitating true on-off power control from logic circuit supply voltages.

Formerly developmental type TA09520.

**Ordering Information**

PART NUMBER	PACKAGE	BRAND
RFD4N06L	TO-251AA	RFD4N06L
RFD4N06LSM	TO-252AA	RFD4N06LSM

NOTE: When ordering, use the entire part number.

**Features**

- 4A, 60V
- $r_{DS(ON)} = 0.600\Omega$
- Design Optimized for 5 Volt Gate Drive
- Can be Driven Directly From Q-MOS, N-MOS, or TTL Circuits
- SOA is Power Dissipation Limited
- 175°C Rated Junction Temperature
- Logic Level Gate
- High Input Impedance
- Related Literature
  - TB334 "Guidelines for Soldering Surface Mount Components to PC Boards"

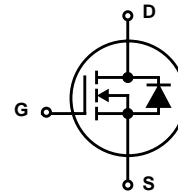
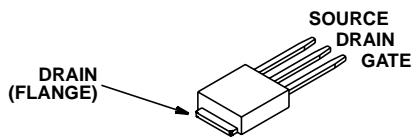
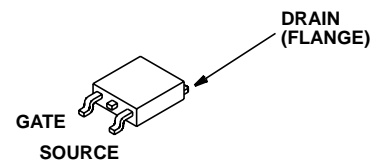
**Symbol**

**Packaging**
**JEDEC TO-251AA**

**JEDEC TO-252AA**

# RFD4N06L, RFD4N06LSM

## Absolute Maximum Ratings $T_C = 25^\circ\text{C}$ , Unless Otherwise Specified

	RFD4N06L	RFD4N06LSM	UNITS
Drain to Source Breakdown Voltage (Note 1)	60	60	V
Drain to Gate Voltage (Note 1)	60	60	V
Gate to Source Voltage	$\pm 10$		V
Continuous Drain Current	4	4	A
Pulsed Drain Current (Note 3)	10	10	A
Maximum Power Dissipation	30	30	W
Derated above $25^\circ\text{C}$ .	0.20	0.20	W/ $^\circ\text{C}$
Operating and Storage Temperature	-55 to 175	-55 to 175	$^\circ\text{C}$
Maximum Temperature for Soldering			
Leads at 0.063in (1.6mm) from Case for 10s.	300	300	$^\circ\text{C}$
Package Body for 10s, See Techbrief 334	260	260	$^\circ\text{C}$

CAUTION: Stresses above those listed in "Absolute Maximum Ratings" may cause permanent damage to the device. This is a stress only rating and operation of the device at these or any other conditions above those indicated in the operational sections of this specification is not implied.

### NOTE:

1.  $T_J = 25^\circ\text{C}$  to  $150^\circ\text{C}$ .

## Electrical Specifications $T_C = 25^\circ\text{C}$ , Unless Otherwise Specified

PARAMETER	SYMBOL	TEST CONDITIONS	MIN	TYP	MAX	UNITS
Drain to Source Breakdown Voltage	$BV_{DSS}$	$I_D = 1\text{mA}$ , $V_{GS} = 0\text{V}$	60	-	-	V
Gate to Threshold Voltage	$V_{GS(TH)}$	$V_{GS} = V_{DS}$ , $I_D = 250\mu\text{A}$	1	-	2.5	V
Zero Gate Voltage Drain Current	$I_{DSS}$	$T_C = 25^\circ\text{C}$ , $V_{DS} = 50\text{V}$ , $V_{GS} = 0\text{V}$	-	-	1	$\mu\text{A}$
		$T_C = 125^\circ\text{C}$ , $V_{DS} = 50\text{V}$ , $V_{GS} = 0\text{V}$	-	-	50	$\mu\text{A}$
Gate to Source Leakage Current	$I_{GSS}$	$V_{GS} = 10\text{V}$ , $V_{DS} = 0\text{V}$	-	-	100	nA
Drain to Source On Voltage (Note 2)	$V_{DS(ON)}$	$I_D = 1\text{A}$ , $V_{GS} = 5\text{V}$	-	-	0.8	V
		$I_D = 2\text{A}$ , $V_{GS} = 5\text{V}$	-	-	2.0	V
		$I_D = 4\text{A}$ , $V_{GS} = 7.5\text{V}$	-	-	4.0	V
Drain to Source On Resistance (Note 2)	$r_{DS(ON)}$	$I_D = 1\text{A}$ , $V_{GS} = 5\text{V}$	-	-	0.600	$\Omega$
Forward Transconductance (Note 2)	$V_{(plateau)}$	$V_{DS} = 15\text{V}$ , $I_D = 4\text{A}$	-	-	4.5	V
Turn-On Delay Time	$t_{d(ON)}$	$V_{DD} = 30\text{V}$ , $I_D = 1\text{A}$ , $R_{GS} = 6.25\Omega$ , $V_{GS} = 5\text{V}$	-	-	20	ns
Rise Time	$t_r$		-	-	130	ns
Turn-Off Delay Time	$t_{d(OFF)}$		-	-	40	ns
Fall Time	$t_f$		-	-	160	ns
Total Gate Charge (Gate to Source + Gate to Drain)	$Q_{g(TOT)}$	$V_{GS} = 0-10\text{V}$	-	-	8	nC
Gate Charge at 5V	$Q_{g(5)}$	$V_{GS} = 0-5\text{V}$				
Threshold Gate Charge	$Q_{g(TH)}$	$V_{GS} = 0-1\text{V}$				
Thermal Resistance Junction to Case	$R_{\theta JC}$		-	-	5	$^\circ\text{C/W}$

## Source to Drain Diode Specifications

PARAMETER	SYMBOL	TEST CONDITIONS	MIN	TYP	MAX	UNITS
Source to Drain Diode Voltage (Note 2)	$V_{SD}$	$I_{SD} = 1\text{A}$	-	-	1.4	V
Reverse Recovery Time	$t_{rr}$	$I_{SD} = 2\text{A}$ , $dI_{SD}/dt = 100\text{A}/\mu\text{s}$	-	150	-	ns

### NOTES:

2. Pulsed: pulse duration =  $300\mu\text{s}$  max, duty cycle = 2%.
3. Repetitive rating: pulse width limited by maximum junction temperature.

Typical Performance Curves Unless Otherwise Specified

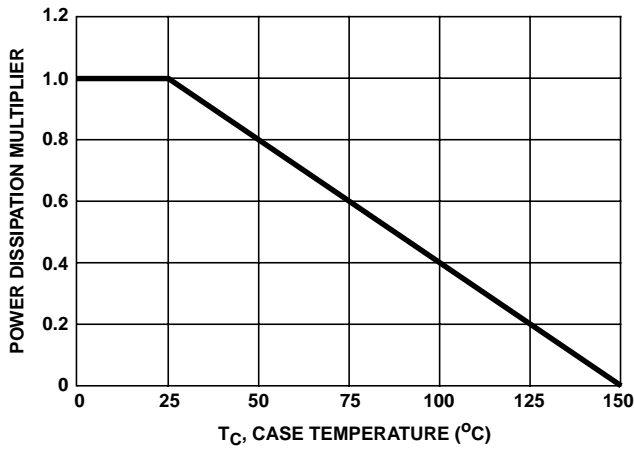

FIGURE 1. NORMALIZED POWER DISSIPATION vs CASE TEMPERATURE

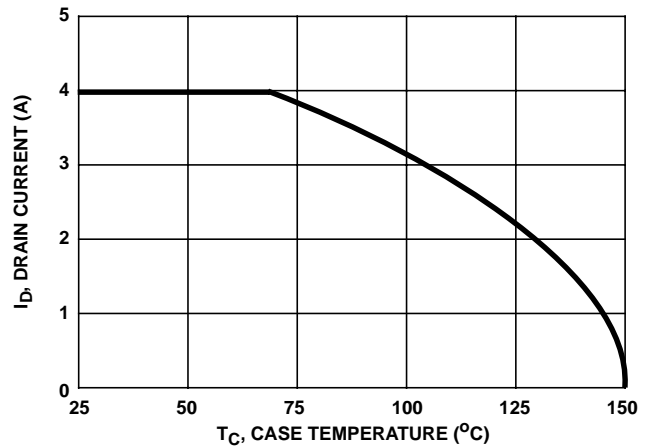

FIGURE 2. MAXIMUM CONTINUOUS DRAIN CURRENT vs CASE TEMPERATURE

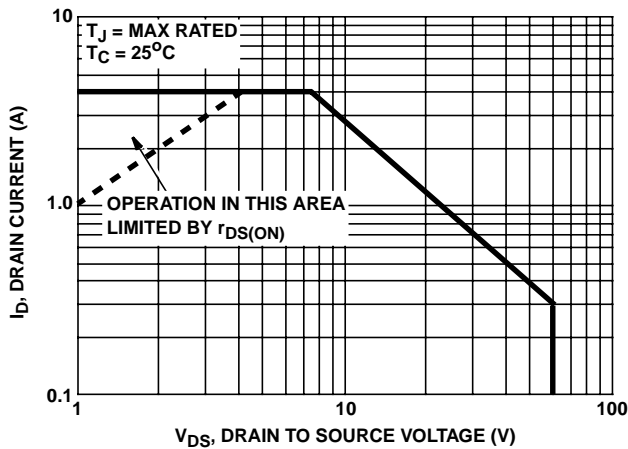

FIGURE 3. FORWARD BIAS SAFE OPERATING AREA

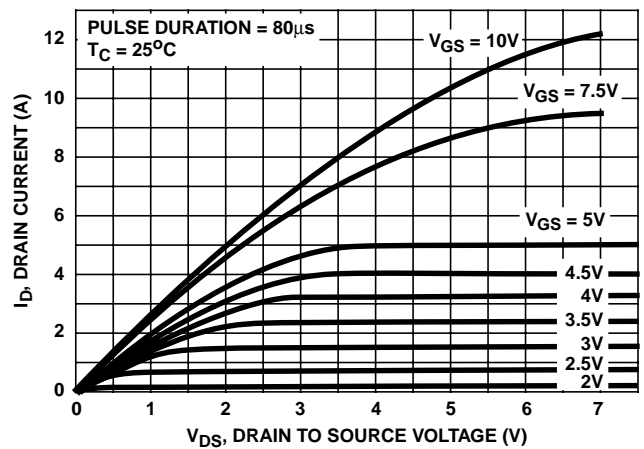

FIGURE 4. SATURATION CHARACTERISTICS

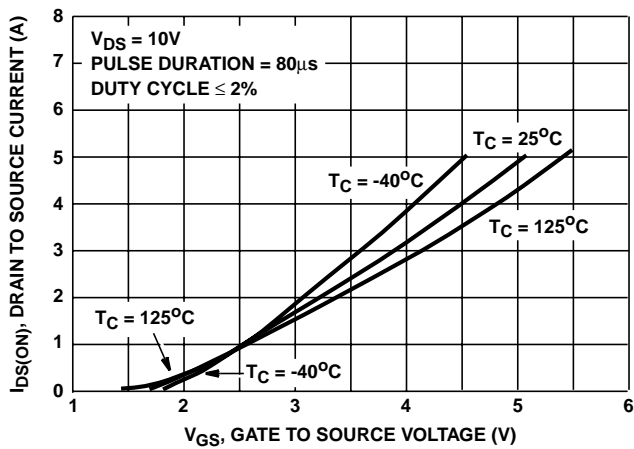

FIGURE 5. TRANSFER CHARACTERISTICS

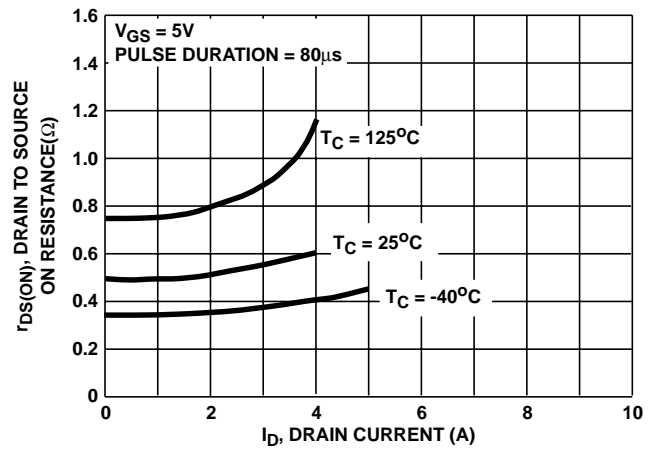

FIGURE 6. DRAIN TO SOURCE ON RESISTANCE vs DRAIN CURRENT

Typical Performance Curves Unless Otherwise Specified (Continued)

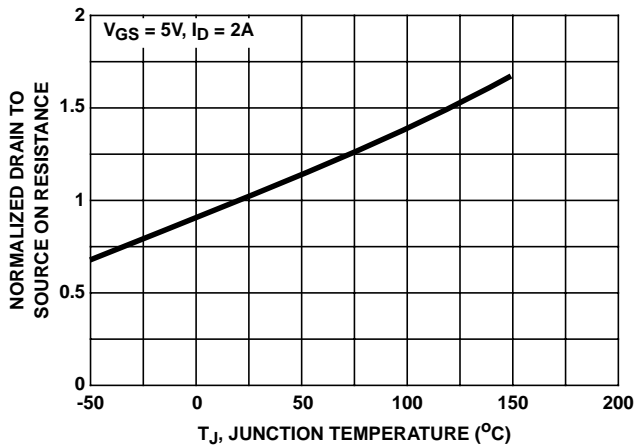

FIGURE 7. NORMALIZED DRAIN TO SOURCE ON RESISTANCE vs JUNCTION TEMPERATURE

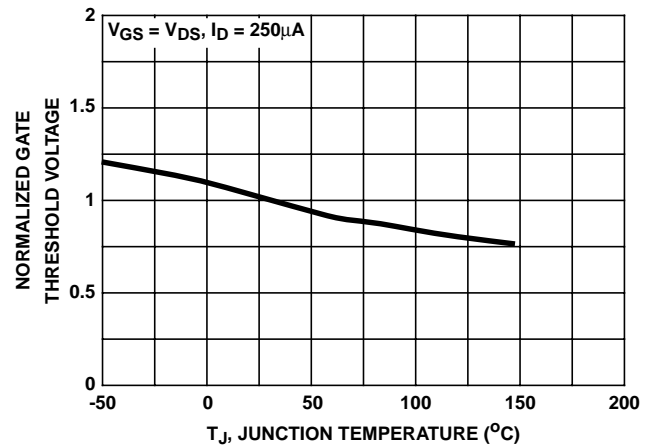

FIGURE 8. NORMALIZED GATE THRESHOLD VOLTAGE vs JUNCTION TEMPERATURE

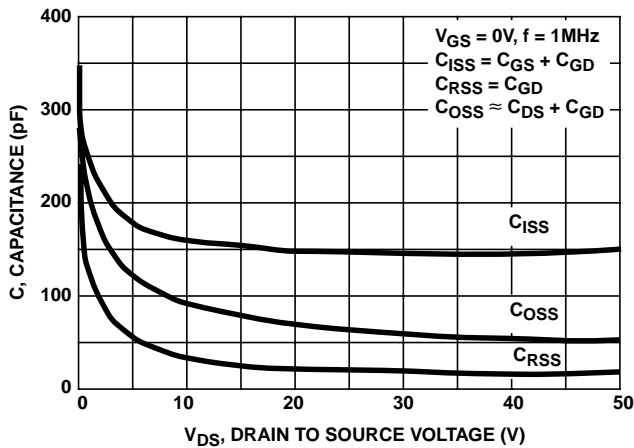
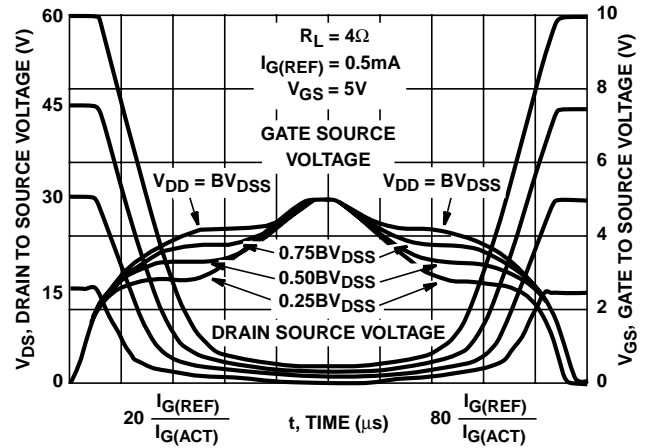

FIGURE 9. CAPACITANCE vs DRAIN TO SOURCE VOLTAGE



NOTE: Refer to Intersil Application Notes AN7254 and AN7260.

FIGURE 10. NORMALIZED SWITCHING WAVEFORMS FOR CONSTANT GATE CURRENT

Test Circuits and Waveforms

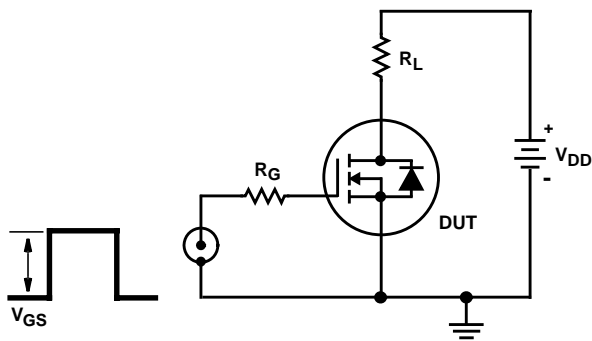

FIGURE 11. SWITCHING TIME TEST CIRCUIT

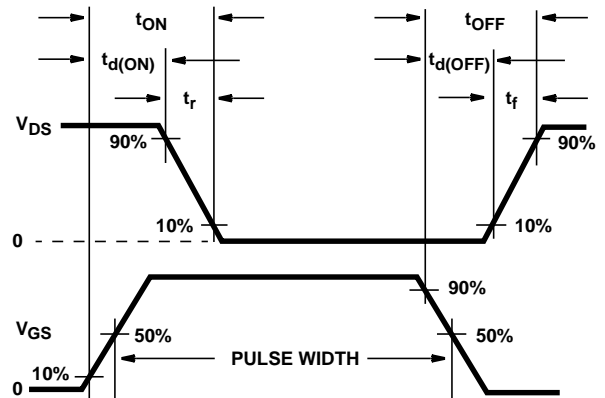

FIGURE 12. RESISTIVE SWITCHING WAVEFORMS

All Intersil semiconductor products are manufactured, assembled and tested under **ISO9000** quality systems certification.

*Intersil semiconductor products are sold by description only. Intersil Corporation reserves the right to make changes in circuit design and/or specifications at any time without notice. Accordingly, the reader is cautioned to verify that data sheets are current before placing orders. Information furnished by Intersil is believed to be accurate and reliable. However, no responsibility is assumed by Intersil or its subsidiaries for its use; nor for any infringements of patents or other rights of third parties which may result from its use. No license is granted by implication or otherwise under any patent or patent rights of Intersil or its subsidiaries.*

For information regarding Intersil Corporation and its products, see web site <http://www.intersil.com>

### **Sales Office Headquarters**

#### **NORTH AMERICA**

Intersil Corporation  
P. O. Box 883, Mail Stop 53-204  
Melbourne, FL 32902  
TEL: (407) 724-7000  
FAX: (407) 724-7240

#### **EUROPE**

Intersil SA  
Mercure Center  
100, Rue de la Fusee  
1130 Brussels, Belgium  
TEL: (32) 2.724.2111  
FAX: (32) 2.724.22.05

#### **ASIA**

Intersil (Taiwan) Ltd.  
7F-6, No. 101 Fu Hsing North Road  
Taipei, Taiwan  
Republic of China  
TEL: (886) 2 2716 9310  
FAX: (886) 2 2715 3029