

**50A, 1000V Hyperfast Diode**

The RHRG50100 is a hyperfast diode with soft recovery characteristics ( $t_{rr} < 75ns$ ). It has half the recovery time of ultrafast diodes and is of silicon nitride passivated ion-implanted epitaxial planar construction.

This device is intended for use as a freewheeling/clamping diode and rectifier in a variety of switching power supplies and other power switching applications. Its low stored charge and hyperfast soft recovery minimize ringing and electrical noise in many power switching circuits, thus reducing power loss in the switching transistors.

Formerly developmental type TA49066.

**Ordering Information**

PART NUMBER	PACKAGE	BRAND
RHRG50100	TO-247	RHRG50100

NOTE: When ordering, use the entire part number.

**Symbol**



**Features**

- Hyperfast with Soft Recovery . . . . . <75ns
- Operating Temperature . . . . . 175°C
- Reverse Voltage . . . . . 1000V
- Avalanche Energy Rated
- Planar Construction

**Applications**

- Switching Power Supplies
- Power Switching Circuits
- General Purpose

**Packaging**

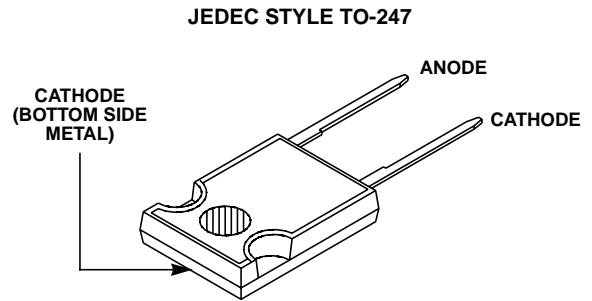

**Absolute Maximum Ratings**  $T_C = 25^\circ C$

	RHRG50100	UNITS
Peak Repetitive Reverse Voltage . . . . .	$V_{RRM}$ 1000	V
Working Peak Reverse Voltage . . . . .	$V_{RWM}$ 1000	V
DC Blocking Voltage . . . . .	$V_R$ 1000	V
Average Rectified Forward Current . . . . . ( $T_C = 60^\circ C$ )	$I_{F(AV)}$ 50	A
Repetitive Peak Surge Current . . . . . (Square Wave, 20kHz)	$I_{FRM}$ 100	A
Nonrepetitive Peak Surge Current . . . . . (Halfwave, 1 Phase, 60Hz)	$I_{FSM}$ 500	A
Maximum Power Dissipation . . . . .	$P_D$ 150	W
Avalanche Energy (See Figures 7 and 8) . . . . .	$E_{AVL}$ 40	mJ
Operating and Storage Temperature . . . . .	$T_{STG}, T_J$ -65 to 175	°C

**Electrical Specifications**  $T_C = 25^\circ\text{C}$ , Unless Otherwise Specified

SYMBOL	TEST CONDITION	MIN	TYP	MAX	UNITS
$V_F$	$I_F = 50\text{A}$	-	-	3.0	V
	$I_F = 50\text{A}, T_C = 150^\circ\text{C}$	-	-	2.5	V
$I_R$	$V_R = 1000\text{V}$	-	-	250	$\mu\text{A}$
	$V_R = 1000\text{V}, T_C = 150^\circ\text{C}$	-	-	3.0	mA
$t_{rr}$	$I_F = 1\text{A}, dI_F/dt = 100\text{A}/\mu\text{s}$	-	-	75	ns
	$I_F = 50\text{A}, dI_F/dt = 100\text{A}/\mu\text{s}$	-	-	95	ns
$t_a$	$I_F = 50\text{A}, dI_F/dt = 100\text{A}/\mu\text{s}$	-	54	-	ns
$t_b$	$I_F = 50\text{A}, dI_F/dt = 100\text{A}/\mu\text{s}$	-	32	-	ns
$R_{\theta JC}$		-	-	1.0	$^\circ\text{C}/\text{W}$

**DEFINITIONS**

$V_F$  = Instantaneous forward voltage ( $p_w = 300\mu\text{s}, D = 2\%$ ).

$I_R$  = Instantaneous reverse current.

$t_{rr}$  = Reverse recovery time (See Figure 6), summation of  $t_a + t_b$ .

$t_a$  = Time to reach peak reverse current (See Figure 6).

$t_b$  = Time from peak  $I_{RM}$  to projected zero crossing of  $I_{RM}$  based on a straight line from peak  $I_{RM}$  through 25% of  $I_{RM}$  (See Figure 6).

$R_{\theta JC}$  = Thermal resistance junction to case.

$p_w$  = Pulse width.

$D$  = Duty cycle.

**Typical Performance Curves**

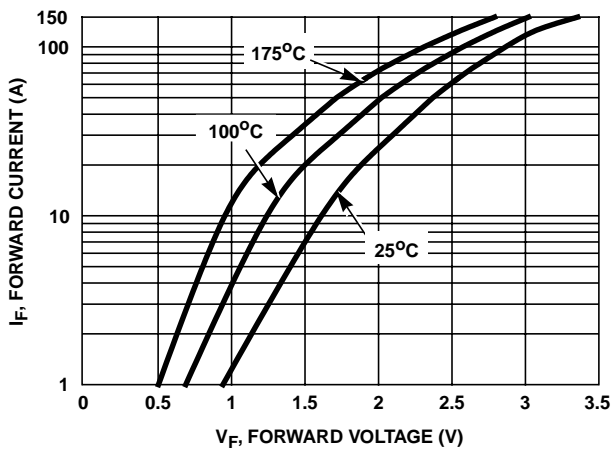

FIGURE 1. FORWARD CURRENT vs FORWARD VOLTAGE

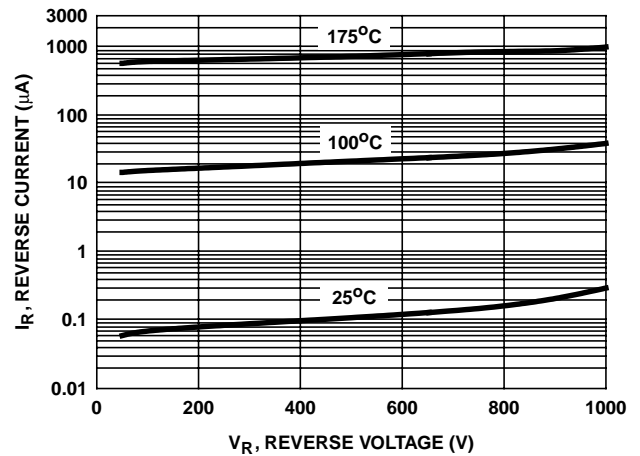

FIGURE 2. REVERSE CURRENT vs REVERSE VOLTAGE

Typical Performance Curves (Continued)

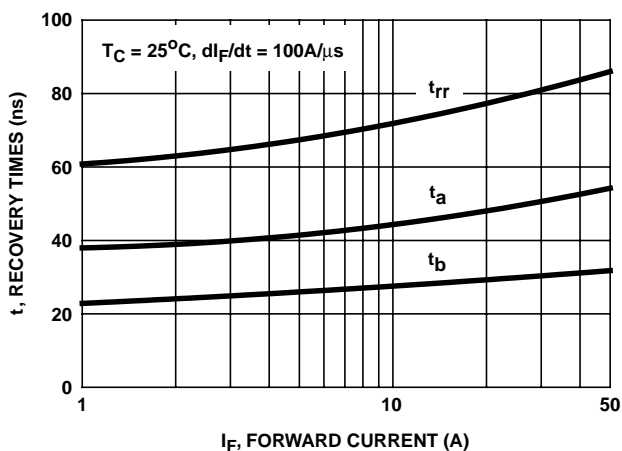

FIGURE 3.  $t_{rr}$ ,  $t_a$  AND  $t_b$  CURVES vs FORWARD CURRENT

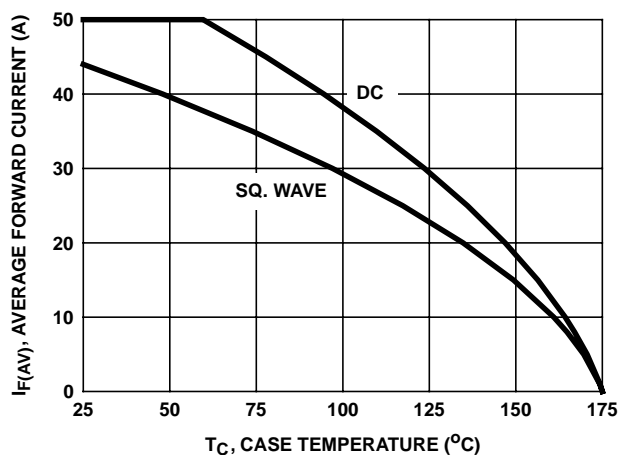

FIGURE 4. CURRENT DERATING CURVE

Test Circuits and Waveforms

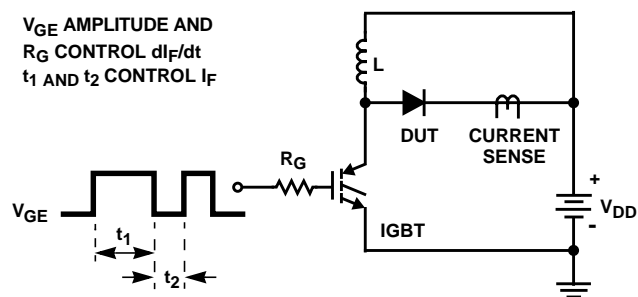

FIGURE 5.  $t_{rr}$  TEST CIRCUIT

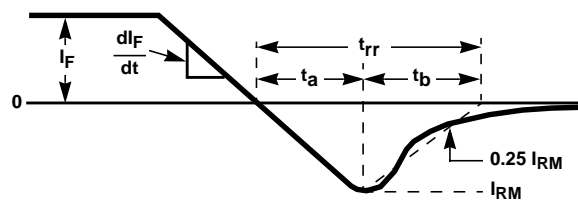

FIGURE 6.  $t_{rr}$  WAVEFORMS AND DEFINITIONS

$I_{MAX} = 1.4\text{A}$   
 $L = 40\text{mH}$   
 $R < 0.1\Omega$   
 $E_{AVL} = 1/2LI^2 [V_{R(AVL)}/(V_{R(AVL)} - V_{DD})]$   
 $Q_1 = \text{IGBT (BV}_{CES} > \text{DUT } V_{R(AVL)})$

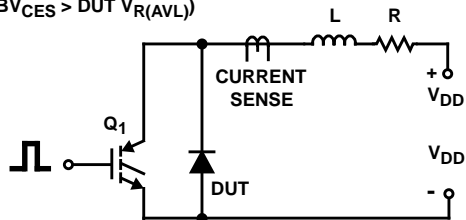

FIGURE 7. AVALANCHE ENERGY TEST CIRCUIT

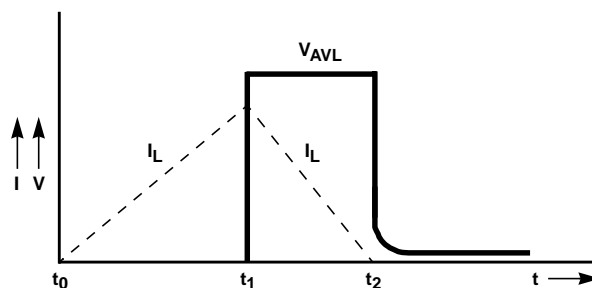

FIGURE 8. AVALANCHE CURRENT AND VOLTAGE WAVEFORMS

All Intersil semiconductor products are manufactured, assembled and tested under ISO9000 quality systems certification.

Intersil semiconductor products are sold by description only. Intersil Corporation reserves the right to make changes in circuit design and/or specifications at any time without notice. Accordingly, the reader is cautioned to verify that data sheets are current before placing orders. Information furnished by Intersil is believed to be accurate and reliable. However, no responsibility is assumed by Intersil or its subsidiaries for its use; nor for any infringements of patents or other rights of third parties which may result from its use. No license is granted by implication or otherwise under any patent or patent rights of Intersil or its subsidiaries.

For information regarding Intersil Corporation and its products, see web site [www.intersil.com](http://www.intersil.com)