

7A, 100V, 0.300 Ohm, N-Channel, Logic Level, Power MOSFETs

These N-Channel power MOSFETs are manufactured using a modern process. This process, which uses feature sizes approaching those of LSI integrated circuits gives optimum utilization of silicon, resulting in outstanding performance. They were designed for use in applications such as switching regulators, switching converters, motor drivers, relay drivers and emitter switches for bipolar transistors. This performance is accomplished through a special gate oxide design which provides full rated conductance at gate bias in the 3V to 5V range, thereby facilitating true on-off power control directly from logic level (5V) integrated circuits.

Formerly developmental type TA49046.

Ordering Information

PART NUMBER	PACKAGE	BRAND
RFD7N10LE	TO-251AA	7N10L
RFD7N10LESM	TO-252AA	7N10LE

NOTE: When ordering, use the entire part number. Add suffix 9A to obtain the TO-252AA variant in the tape and reel, i.e., RFD7N10LESM9A.

Features

- 7A, 100V
- $r_{DS(ON)} = 0.300\Omega$
- Temperature Compensating PSPICE® Model
- Can be Driven Directly from CMOS, NMOS, TTL Circuits
- Peak Current vs Pulse Width Curve
- UIS Rating Curve
- 175°C Operating Temperature
- Related Literature
 - TB334 "Guidelines for Soldering Surface Mount Components to PC Boards"

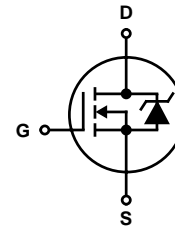
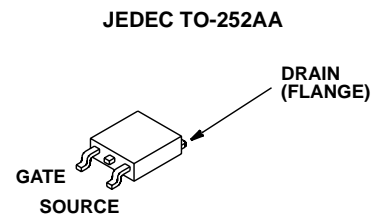
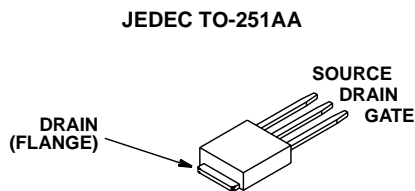
Symbol

Packaging

RFD7N10LE, RFD7N10LESM

Absolute Maximum Ratings $T_C = 25^\circ\text{C}$, Unless Otherwise Specified

	RFD7N10LE, RFD7N10LESM	UNITS
Drain to Source Voltage	100	V
Drain to Gate Voltage	100	V
Gate to Source Voltage	+10, -8	V
Drain Current		
Continuous	7	A
Pulsed Drain Current	Refer to Peak Current Curve	
Pulsed Avalanche Rating	Refer to UIS Curve	
Power Dissipation	47	W
Derate Above 25°C	0.318	$\text{W}/^\circ\text{C}$
Operating and Storage Temperature	-55 to 175	$^\circ\text{C}$
Maximum Temperature for Soldering		
Leads at 0.063in (1.6mm) from Case for 10s	300	$^\circ\text{C}$
Package Body for 10s, See Techbrief 334	260	$^\circ\text{C}$

CAUTION: Stresses above those listed in "Absolute Maximum Ratings" may cause permanent damage to the device. This is a stress only rating and operation of the device at these or any other conditions above those indicated in the operational sections of this specification is not implied.

NOTE:

1. $T_J = 25^\circ\text{C}$ to 150°C .

Electrical Specifications $T_C = 25^\circ\text{C}$, Unless Otherwise Specified

PARAMETER	SYMBOL	TEST CONDITIONS	MIN	TYP	MAX	UNITS
Drain to Source Breakdown Voltage	BV_{DSS}	$I_D = 250\mu\text{A}$, $V_{GS} = 0\text{V}$	100	-	-	V
Gate Threshold Voltage	$V_{GS(TH)}$	$V_{GS} = V_{DS}$, $I_D = 250\mu\text{A}$	1	-	3	V
Zero Gate Voltage Drain Current	I_{DSS}	$V_{DS} = 95\text{V}$, $V_{GS} = 0\text{V}$	-	-	1	μA
		$V_{DS} = 90\text{V}$, $V_{GS} = 0\text{V}$, $T_C = 150^\circ\text{C}$	-	-	250	μA
Gate to Source Leakage Current	I_{GSS}	$V_{GS} = +10, -8\text{V}$	-	-	10	μA
On Resistance	$r_{DS(ON)}$	$I_D = 7\text{A}$, $V_{GS} = 5\text{V}$	-	-	0.300	Ω
Turn-On Time	t_{ON}	$V_{DD} = 50\text{V}$, $I_D = 7\text{A}$ $R_L = 7.1\Omega$, $V_{GS} = 5\text{V}$ $R_{GS} = 2.5\Omega$	-	-	110	ns
Turn-On Delay Time	$t_{d(ON)}$		-	10	-	ns
Rise Time	t_r		-	65	-	ns
Turn-Off Delay Time	$t_{d(OFF)}$		-	23	-	ns
Fall Time	t_f		-	18	-	ns
Turn-Off Time	t_{OFF}		-	-	60	ns
Total Gate Charge	$Q_g(TOT)$	$V_{GS} = 0$ to 10V	-	125	150	nC
Gate Charge at 5V	$Q_g(5)$	$V_{GS} = 0$ to 5V				
Threshold Gate Charge	$Q_g(TH)$	$V_{GS} = 0$ to 1V				
Input Capacitance	C_{ISS}	$V_{DS} = 25\text{V}$, $V_{GS} = 0\text{V}$ $f = 1\text{MHz}$	-	360	-	pF
Output Capacitance	C_{OSS}		-	70	-	pF
Reverse Transfer Capacitance	C_{RSS}		-	20	-	pF
Thermal Resistance Junction to Case	$R_{\theta JC}$		-	-	3.15	$^\circ\text{C}/\text{W}$
Thermal Resistance Junction to Ambient	$R_{\theta JA}$	TO-251 and TO-252 Package	-	-	100	$^\circ\text{C}/\text{W}$

Source to Drain Diode Specifications

PARAMETER	SYMBOL	TEST CONDITIONS	MIN	TYP	MAX	UNITS
Source to Drain Diode Voltage	V_{SD}	$I_{SD} = 7\text{A}$	-	-	1.5	V
Reverse Recovery Time	t_{rr}	$I_{SD} = 7\text{A}$, $dI_{SD}/dt = 100\text{A}/\mu\text{s}$	-	-	130	ns

Typical Performance Curves Unless Otherwise Specified

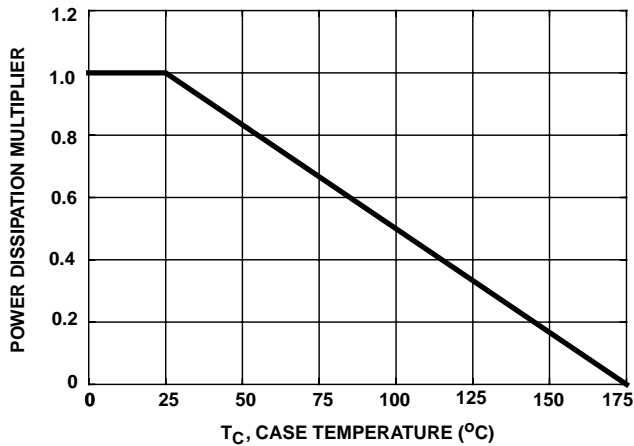

FIGURE 1. NORMALIZED POWER DISSIPATION vs CASE TEMPERATURE

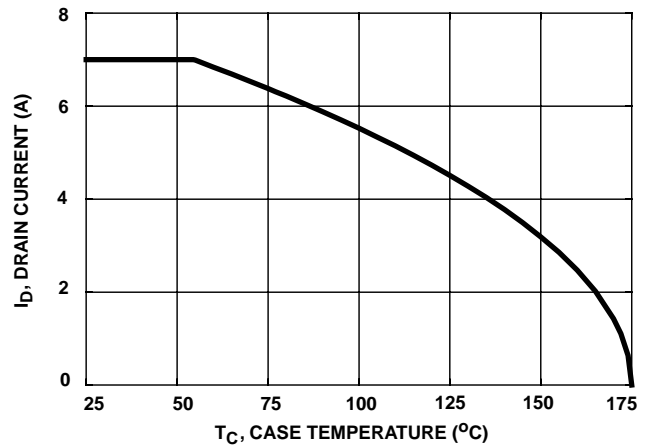

FIGURE 2. MAXIMUM CONTINUOUS DRAIN CURRENT vs CASE TEMPERATURE

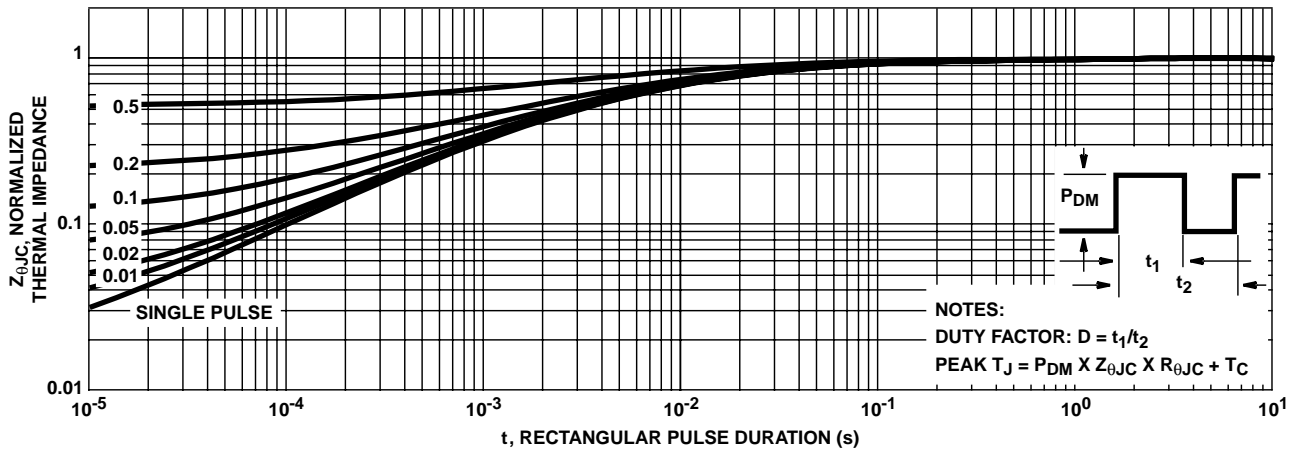

FIGURE 3. NORMALIZED MAXIMUM TRANSIENT THERMAL IMPEDANCE

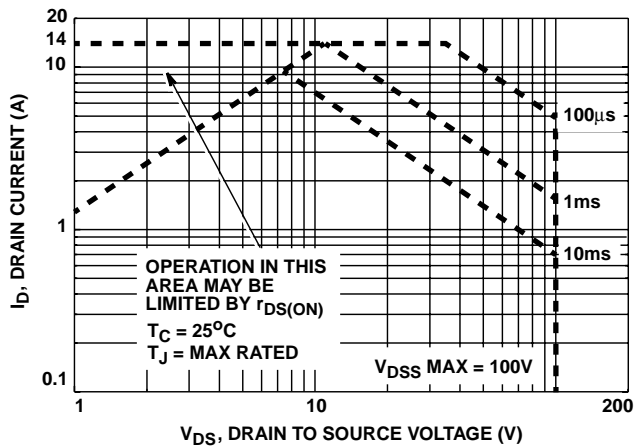

FIGURE 4. FORWARD BIAS SAFE OPERATING AREA

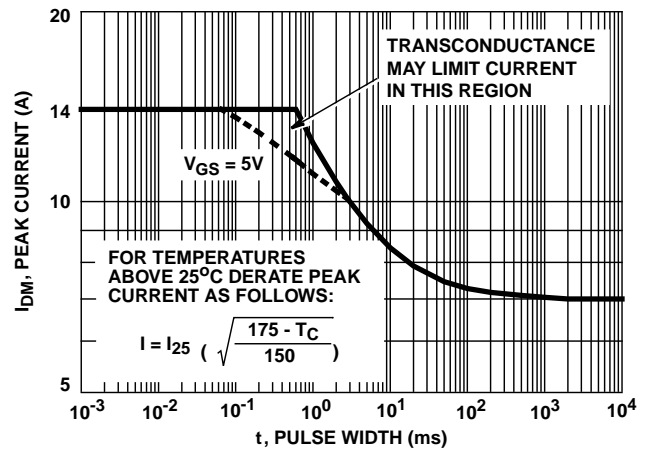

FIGURE 5. PEAK CURRENT CAPABILITY

Typical Performance Curves Unless Otherwise Specified (Continued)

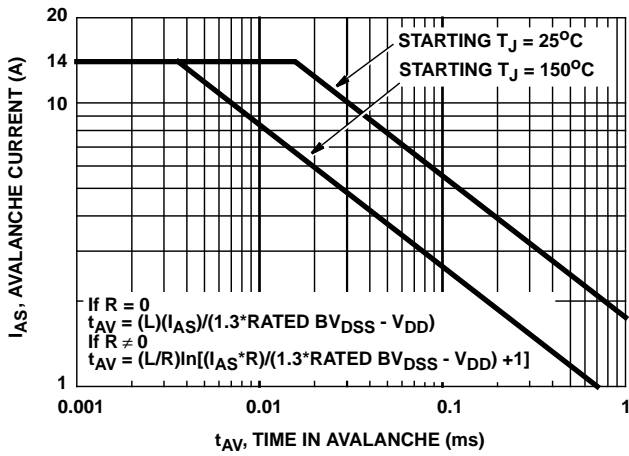

FIGURE 6. UNCLAMPED INDUCTIVE SWITCHING

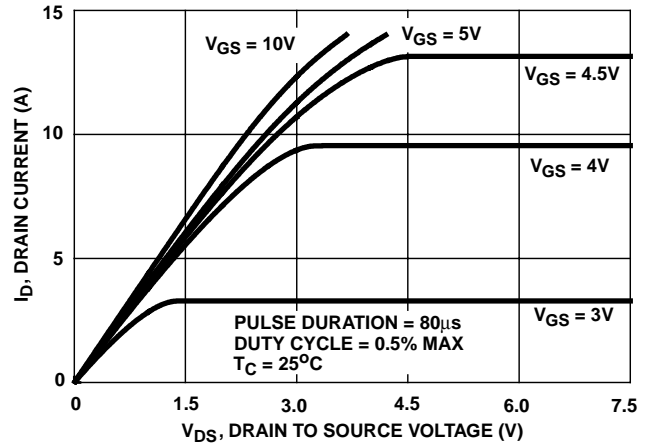

FIGURE 7. SATURATION CHARACTERISTICS

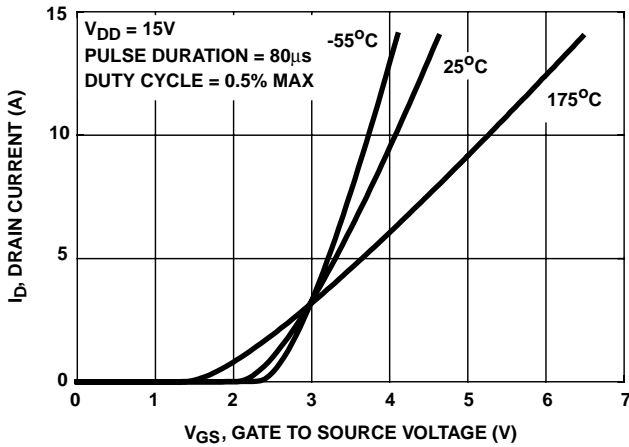

FIGURE 8. TRANSFER CHARACTERISTICS

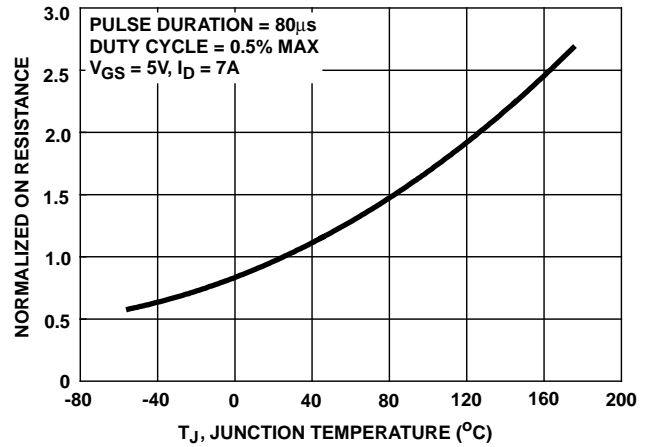

FIGURE 9. NORMALIZED DRAIN TO SOURCE ON RESISTANCE vs JUNCTION TEMPERATURE

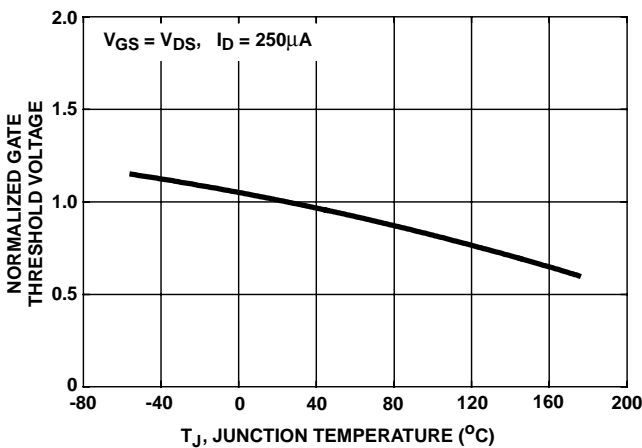

FIGURE 10. NORMALIZED GATE THRESHOLD VOLTAGE vs JUNCTION TEMPERATURE

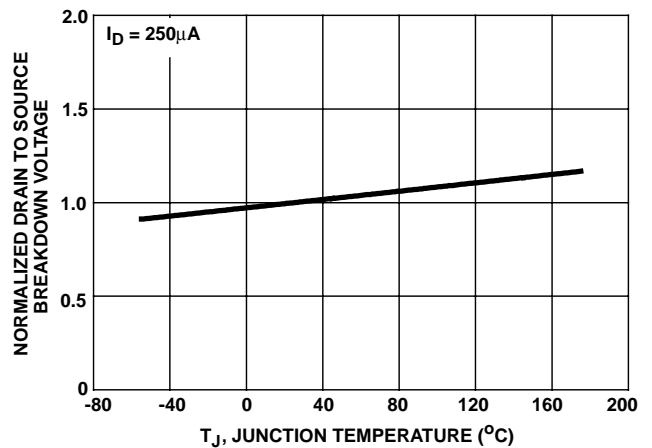

FIGURE 11. NORMALIZED DRAIN TO SOURCE BREAKDOWN VOLTAGE vs JUNCTION TEMPERATURE

Typical Performance Curves Unless Otherwise Specified (Continued)

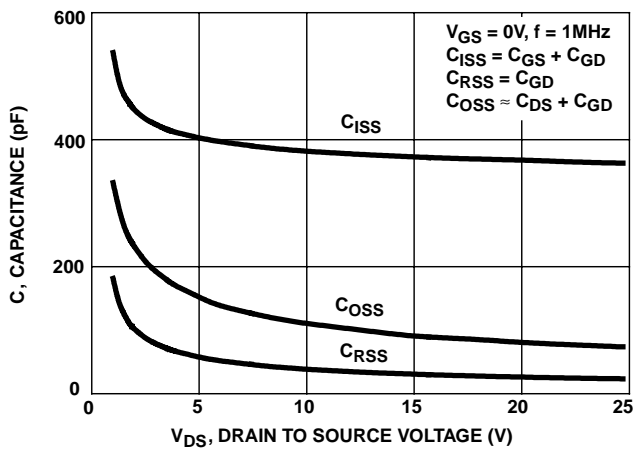
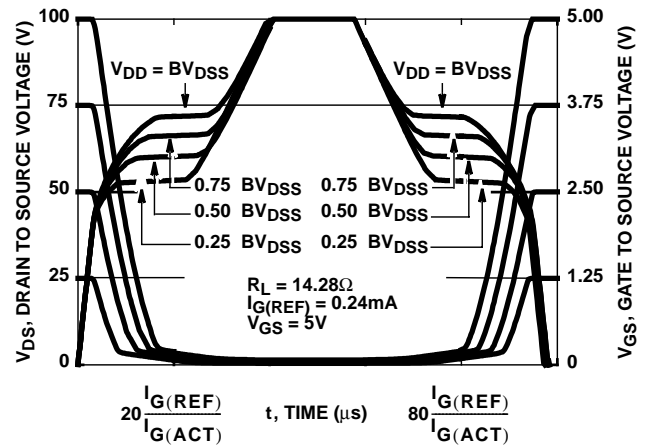

FIGURE 12. CAPACITANCE vs DRAIN TO SOURCE VOLTAGE



NOTE: Refer to Intersil Application Notes AN7254 and AN7260.

FIGURE 13. NORMALIZED SWITCHING WAVEFORMS FOR CONSTANT GATE CURRENT

Test Circuits and Waveforms

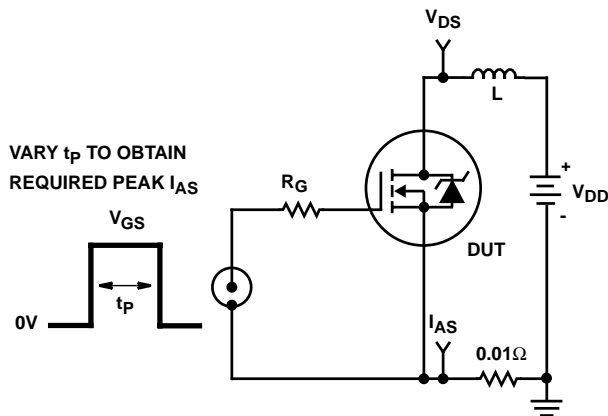

FIGURE 14. UNCLAMPED ENERGY TEST CIRCUIT

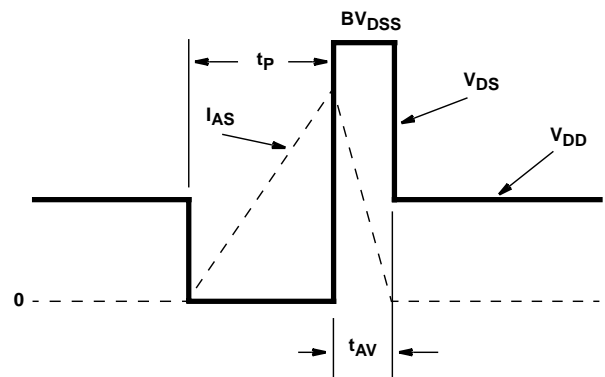

FIGURE 15. UNCLAMPED ENERGY WAVEFORMS

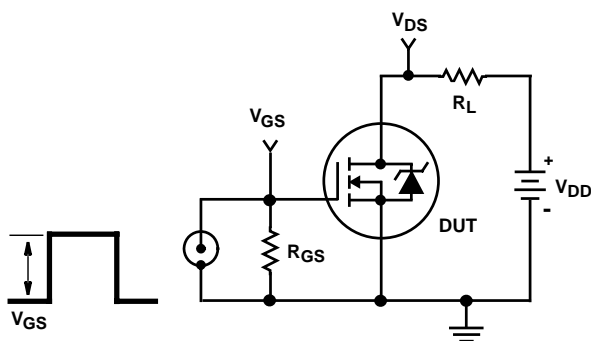

FIGURE 16. RESISTIVE SWITCHING TEST CIRCUIT

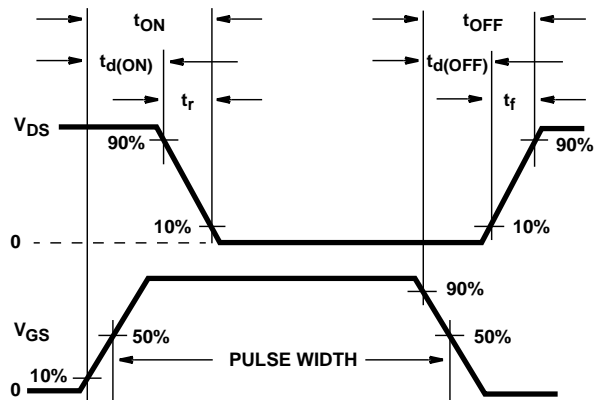

FIGURE 17. RESISTIVE SWITCHING WAVEFORMS

RFD7N10LE, RFD7N10LESM

PSPICE Electrical Model

SUBCKT RFD7N10LE 2 1 3; rev 6/2/93

CA 12 8 7.5e-10
 CB 15 14 7.6e-10
 CIN 6 8 4.03e-10

DBODY 7 5 DBODYMOD
 DBREAK 5 11 DBREAKMOD
 DPLCAP 10 5 DPLCAPMOD

EBREAK 11 7 17 18 116.7
 EDS 14 8 5 8 1
 EGS 13 8 6 8 1
 ESG 6 10 6 8 1
 EVTHRES 6 21 19 8 1
 EVTEMP 20 6 18 22 1

IT 8 17 1

LDRAIN 2 5 1e-9
 LGATE 1 9 3.7e-9
 LSOURCE 3 7 3.4e-9

MMED 16 6 8 8 MMEDMOD
 MSTRO 16 6 8 8 MSTROMOD
 MWEAK 16 21 8 8 MWEAKMOD

RBREAK 17 18 RBREAKMOD 1
 RDRAIN 50 16 RDRAINMOD 9.4e-2
 RGATE 9 20 3.3
 RLDRAIN 2 5 10
 RLGATE 1 9 37
 RLSOURCE 3 7 34
 RSLC1 5 51 RSLCMOD 1e-6
 RSLC2 5 50 1e3
 RSOURCE 8 7 RSOURCEMOD 1.3e-2
 RVTHRES 22 8 RVTHRESMOD 1
 RVTEMP 18 19 RVTEMPMOD 1

S1A 6 12 13 8 S1AMOD
 S1B 13 12 13 8 S1BMOD
 S2A 6 15 14 13 S2AMOD
 S2B 13 15 14 13 S2BMOD

VBAT 22 19 DC 1

ESLC 51 50 VALUE={(V(5,51)/ABS(V(5,51)))*(PWR(V(5,51))/(1e-6*17.3),3.5)}

.MODEL DBODYMOD D (IS = 1.2e-12 RS = 1.2e-2 TRS1 = 1.2e-3 TRS2 = 1.03e-6 CJO = 6.7e-10 TT = 6.9e-8 M = 0.77)
 .MODEL DBREAKMOD D (RS = 9.9e-1 TRS1 = 1e-3 TRS2 = -2e-5)
 .MODEL DPLCAPMOD D (CJO = 4.3e-10 IS = 1e-30 M = 0.9 N = 10)
 .MODEL MMEDMOD NMOS (VTO = 1.88 KP = 5 IS = 1e-30 N = 10 TOX = 1 L = 1u W = 1u RG = 3.3)
 .MODEL MSTROMOD NMOS (VTO = 2.13 KP = 12.4 IS = 1e-30 N = 10 TOX = 1 L = 1u W = 1u)
 .MODEL MWEAKMOD NMOS (VTO = 1.59 KP = 0.12 IS = 1e-30 N = 10 TOX = 1 L = 1u W = 1u RG = 33 RS = 0.1)
 .MODEL RBREAKMOD RES (TC1 = 1.05e-3 TC2 = -5e-7)
 .MODEL RDRAINMOD RES (TC1 = 8.1e-3 TC2 = 2.4e-5)
 .MODEL RSLCMOD RES (TC1 = 3e-3 TC2 = 2e-6)
 .MODEL RSOURCEMOD RES (TC1 = 1e-3 TC2 = 1e-6)
 .MODEL RVTHRESMOD RES (TC1 = -1.5e-3 TC2 = -4.3e-6)
 .MODEL RVTEMPMOD RES (TC1 = -1.6e-3 TC2 = 1.5e-6)

.MODEL S1AMOD VSWITCH (RON = 1e-5 ROFF = 0.1 VON = -4.5 VOFF = -2.5)
 .MODEL S1BMOD VSWITCH (RON = 1e-5 ROFF = 0.1 VON = -2.5 VOFF = -4.5)
 .MODEL S2AMOD VSWITCH (RON = 1e-5 ROFF = 0.1 VON = -0.3 VOFF = 0.2)
 .MODEL S2BMOD VSWITCH (RON = 1e-5 ROFF = 0.1 VON = 0.2 VOFF = -0.3)

.ENDS

NOTE: For further discussion of the PSPICE model consult A New PSPICE Sub-Circuit for the Power MOSFET Featuring Global Temperature Options; IEEE Power Electronics Specialist Conference Records 1991.

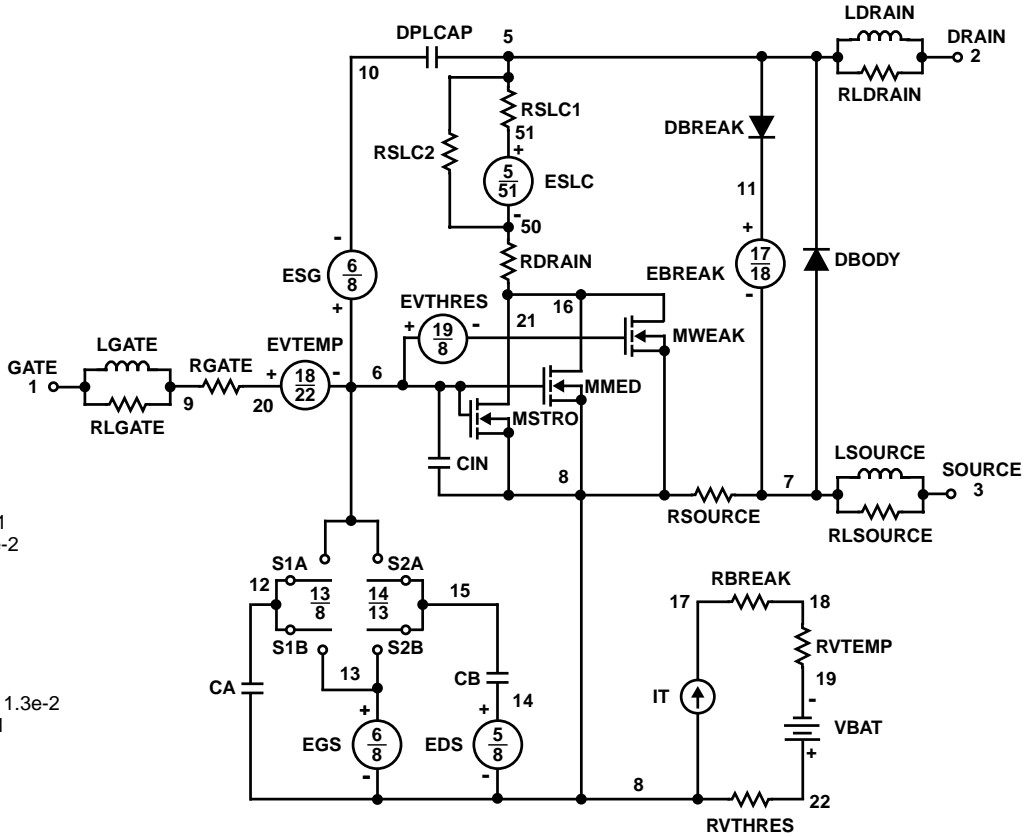

All Intersil semiconductor products are manufactured, assembled and tested under **ISO9000** quality systems certification.

Intersil semiconductor products are sold by description only. Intersil Corporation reserves the right to make changes in circuit design and/or specifications at any time without notice. Accordingly, the reader is cautioned to verify that data sheets are current before placing orders. Information furnished by Intersil is believed to be accurate and reliable. However, no responsibility is assumed by Intersil or its subsidiaries for its use; nor for any infringements of patents or other rights of third parties which may result from its use. No license is granted by implication or otherwise under any patent or patent rights of Intersil or its subsidiaries.

For information regarding Intersil Corporation and its products, see web site <http://www.intersil.com>

Sales Office Headquarters

NORTH AMERICA

Intersil Corporation
P. O. Box 883, Mail Stop 53-204
Melbourne, FL 32902
TEL: (407) 724-7000
FAX: (407) 724-7240

EUROPE

Intersil SA
Mercure Center
100, Rue de la Fusee
1130 Brussels, Belgium
TEL: (32) 2.724.2111
FAX: (32) 2.724.22.05

ASIA

Intersil (Taiwan) Ltd.
7F-6, No. 101 Fu Hsing North Road
Taipei, Taiwan
Republic of China
TEL: (886) 2 2716 9310
FAX: (886) 2 2715 3029