

### 3.1A, 100V, 1.200 Ohm, P-Channel Power MOSFETs

These are advanced power MOSFETs designed, tested, and guaranteed to withstand a specific level of energy in the avalanche breakdown mode of operation. These are P-Channel enhancement mode silicon gate power field-effect transistors designed for applications such as switching regulators, switching converters, motor drivers, relay drivers, and drivers for high power bipolar switching transistors requiring high speed and low gate drive power. These types can be operated directly from integrated circuits.

Formerly developmental type TA17541.

### Ordering Information

PART NUMBER	PACKAGE	BRAND
IRFR9110	TO-252AA	IF9110
IRFU9110	TO-251AA	IF9110

NOTE: When ordering, use the entire part number. Add the suffix 9A to obtain the TO-252AA variant in the tape and reel, i.e., IRFR91109A.

### Features

- 3.1A, 100V
- $r_{DS(ON)} = 1.200\Omega$
- Temperature Compensating PSPICE™ Model
- Peak Current vs Pulse Width Curve
- UIS Rating Curve
- Related Literature
  - TB334 "Guidelines for Soldering Surface Mount Components to PC Boards"

### Symbol

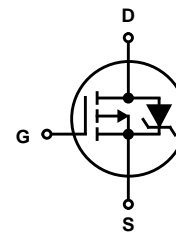

### Packaging

JEDEC TO-251AA

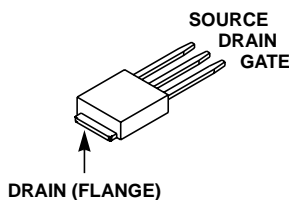

JEDEC TO-252AA

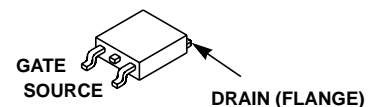

# IRFR9110, IRFU9110

## Absolute Maximum Ratings $T_C = 25^\circ\text{C}$ , Unless Otherwise Specified

	IRFR9110, IRFU9110	UNITS
Drain to Source Voltage . . . . .	$V_{DSS}$ -100	V
Drain to Gate Voltage . . . . .	$V_{DGR}$ -100	V
Gate to Source Voltage . . . . .	$V_{GS}$ $\pm 20$	V
Continuous Drain Current . . . . .	$I_D$ 3.1	A
Pulsed Drain Current . . . . .	$I_{DM}$ Refer to Peak Current Curve	
Single Pulse Avalanche Rating . . . . .	$E_{AS}$ Refer to UIS Curve	
Power Dissipation . . . . .	$P_D$ 25	W
Linear Derating Factor . . . . .	0.2	W/ $^\circ\text{C}$
Operating and Storage Temperature . . . . .	$T_J, T_{STG}$ -55 to 150	$^\circ\text{C}$
Maximum Temperature for Soldering		
Leads at 0.063in (1.6mm) from Case for 10s . . . . .	$T_L$ 300	$^\circ\text{C}$
Package Body for 10s, See Techbrief 334 . . . . .	$T_{pkg}$ 260	$^\circ\text{C}$

CAUTION: Stresses above those listed in "Absolute Maximum Ratings" may cause permanent damage to the device. This is a stress only rating and operation of the device at these or any other conditions above those indicated in the operational sections of this specification is not implied.

**NOTE:**

- $T_J = 25^\circ\text{C}$  to  $125^\circ\text{C}$ .

## Electrical Specifications $T_C = 25^\circ\text{C}$ , Unless Otherwise Specified

PARAMETER	SYMBOL	TEST CONDITIONS	MIN	TYP	MAX	UNITS	
Drain to Source Breakdown Voltage	$BV_{DSS}$	$I_D = 250\mu\text{A}, V_{GS} = 0\text{V}$	-100	-	-	V	
Gate to Threshold Voltage	$V_{GS(TH)}$	$V_{GS} = V_{DS}, I_D = 250\mu\text{A}$	-2.0	-	-4.0	V	
Zero Gate Voltage Drain Current	$I_{DSS}$	$V_{DS} = -100\text{V}, V_{GS} = 0\text{V}$	$T_C = 25^\circ\text{C}$	-	-	-1	$\mu\text{A}$
			$T_C = 150^\circ\text{C}$	-	-	-50	$\mu\text{A}$
Gate to Source Leakage Current	$I_{GSS}$	$V_{GS} = \pm 20\text{V}$	-	-	100	nA	
On Resistance	$r_{DS(ON)}$	$I_D = 1.9\text{A}, V_{GS} = -10\text{V}$	-	-	1.200	$\Omega$	
Turn-On Time	$t_{ON}$	$V_{DD} = -50\text{V}, I_D = 4\text{A}$ $R_L = 11\Omega, V_{GS} = -10\text{V}$ $R_{GS} = 24\Omega$	-	-	50	ns	
Turn-On Delay Time	$t_{d(ON)}$		-	10	-	ns	
Rise Time	$t_r$		-	27	-	ns	
Turn-Off Delay Time	$t_{d(OFF)}$		-	15	-	ns	
Fall Time	$t_f$		-	17	-	ns	
Turn-Off Time	$t_{OFF}$		-	-	50	ns	
Total Gate Charge	$Q_g$		$V_{GS} = 0$ to $-10\text{V}$	$V_{DD} = -80\text{V}, I_D = 3.1\text{A}, R_L = 25.8\Omega$	-	-	8.7
Gate to Drain Charge	$Q_{gd}$	-			-	4.1	nC
Gate to Source Charge	$Q_{gs}$	-			-	2.2	nC
Input Capacitance	$C_{ISS}$	$V_{DS} = -25\text{V}, V_{GS} = 0\text{V}$ $f = 1\text{MHz}$	-	290	-	pF	
Output Capacitance	$C_{OSS}$		-	94	-	pF	
Reverse Transfer Capacitance	$C_{RSS}$		-	18	-	pF	
Thermal Resistance Junction to Case	$R_{\theta JC}$		-	-	5.00	$^\circ\text{C}/\text{W}$	
Thermal Resistance Junction to Ambient	$R_{\theta JA}$		-	-	100	$^\circ\text{C}/\text{W}$	

## Source to Drain Diode Ratings and Specifications

PARAMETER	SYMBOL	TEST CONDITIONS	MIN	TYP	MAX	UNITS
Source to Drain Diode Voltage	$V_{SD}$	$I_{SD} = -3.1\text{A}$	-	-	-5.5	V
Reverse Recovery Time	$t_{rr}$	$I_{SD} = -4.0\text{A}, dI_{SD}/dt = -100\text{A}/\mu\text{s}$	-	105	160	ns
Reverse Recovery Charge	$Q_{RR}$		0.51	1.0	$\mu\text{C}$	

Typical Performance Curves Unless Otherwise Specified

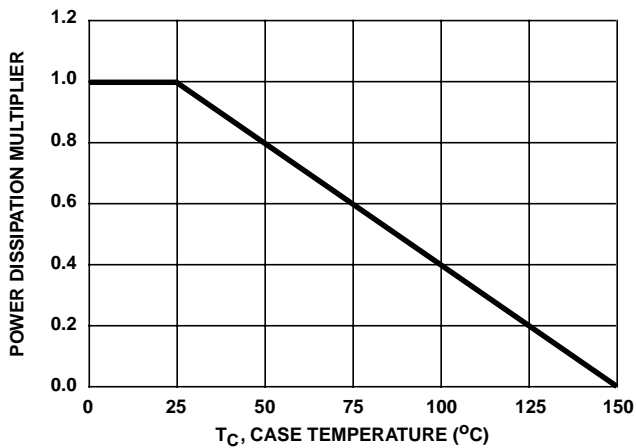

FIGURE 1. NORMALIZED POWER DISSIPATION vs CASE TEMPERATURE

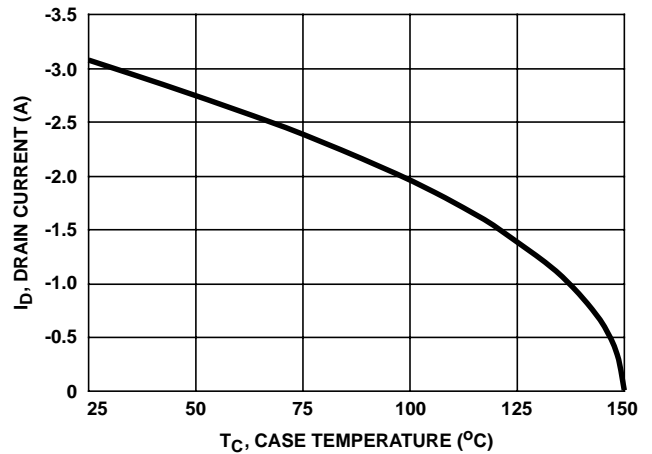

FIGURE 2. MAXIMUM CONTINUOUS DRAIN CURRENT vs CASE TEMPERATURE

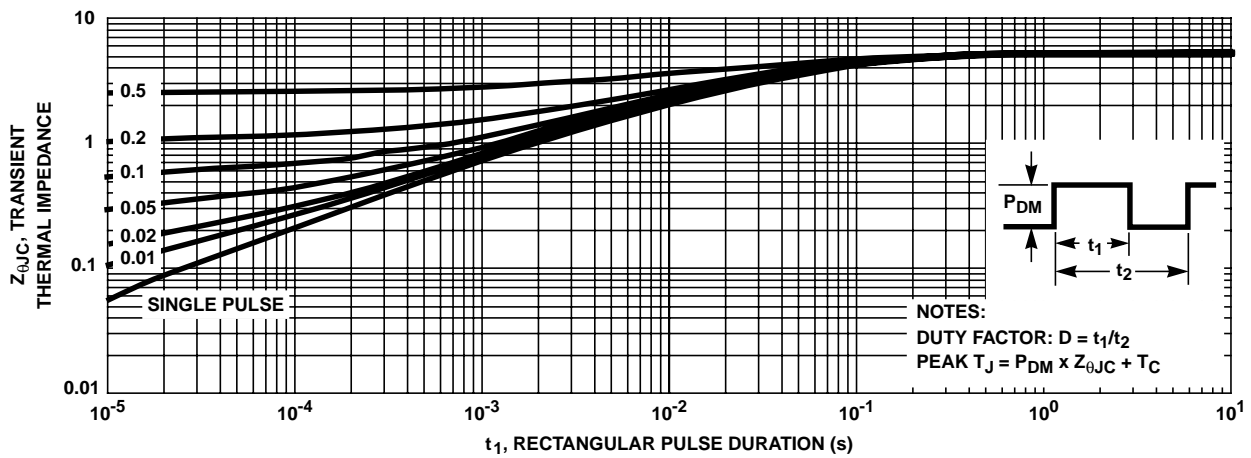

FIGURE 3. MAXIMUM TRANSIENT THERMAL IMPEDANCE

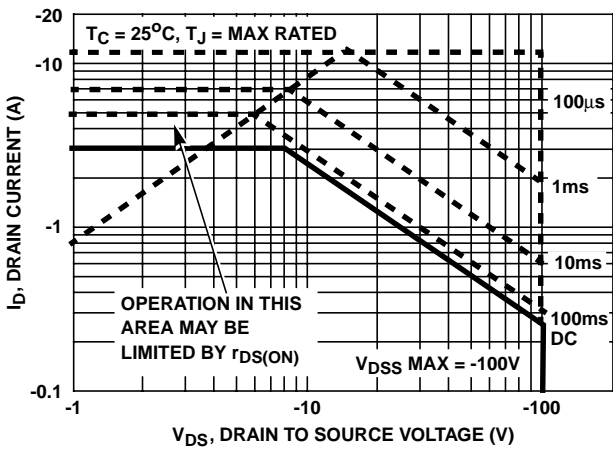

FIGURE 4. FORWARD BIAS SAFE OPERATING AREA

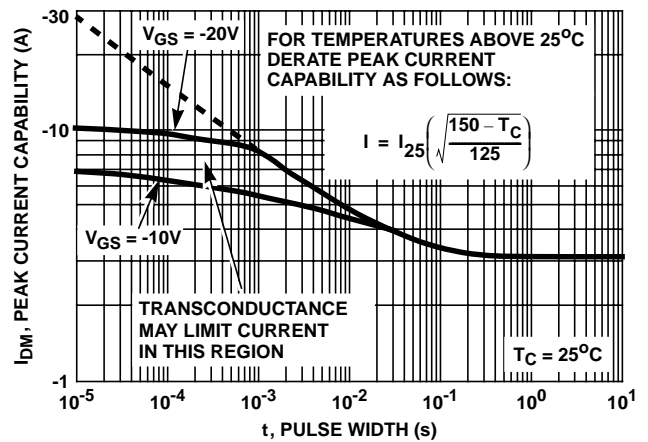

FIGURE 5. PEAK CURRENT CAPABILITY

Typical Performance Curves Unless Otherwise Specified (Continued)

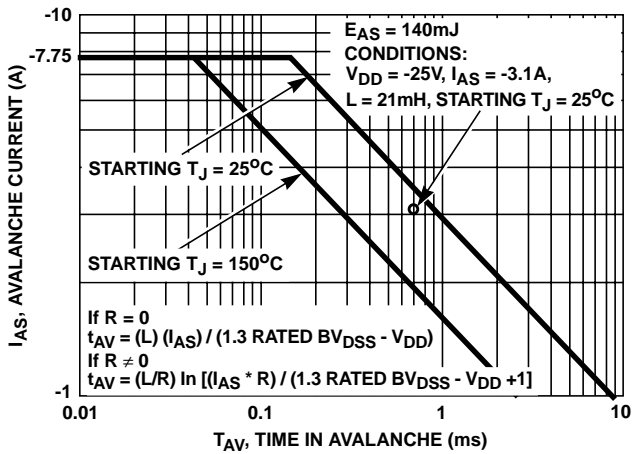

FIGURE 6. UNCLAMPED INDUCTIVE SWITCHING

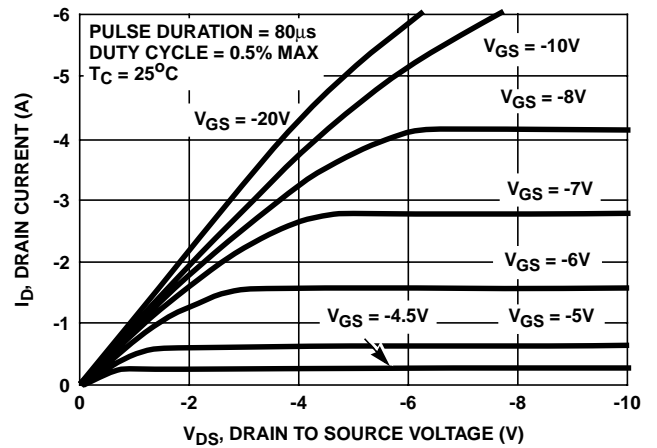

FIGURE 7. SATURATION CHARACTERISTICS

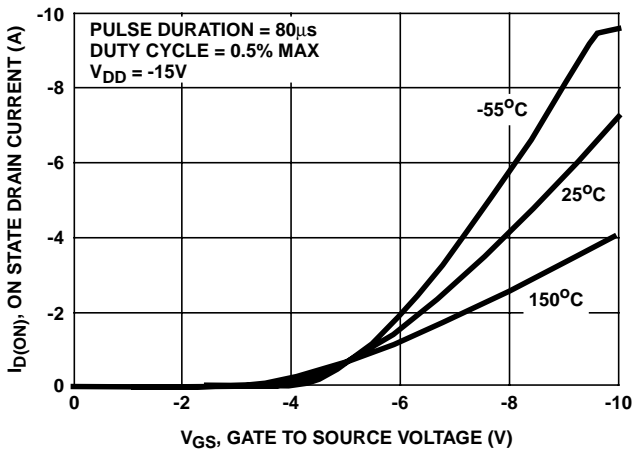

FIGURE 8. TRANSFER CHARACTERISTICS

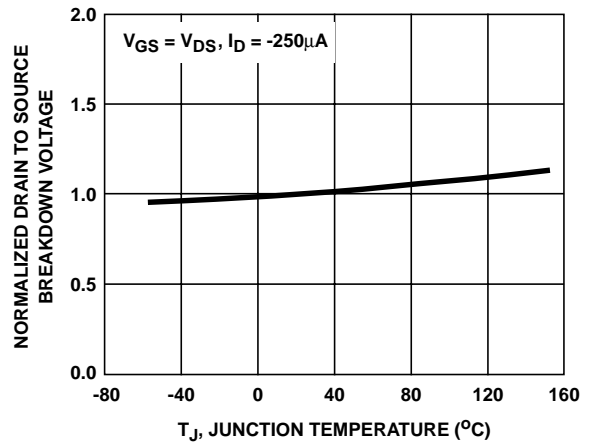

FIGURE 9. NORMALIZED DRAIN TO SOURCE BREAKDOWN VOLTAGE vs JUNCTION TEMPERATURE

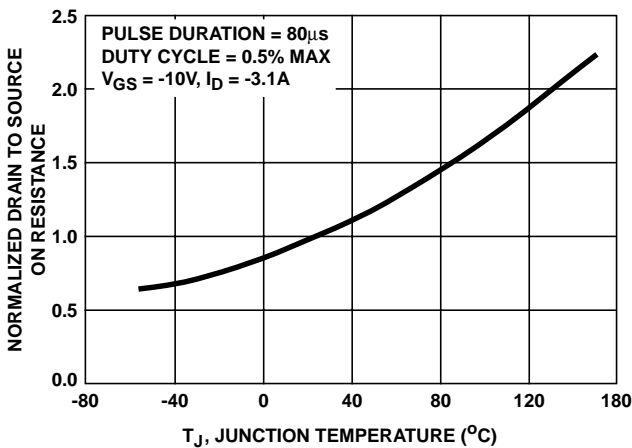

FIGURE 10. NORMALIZED DRAIN TO SOURCE ON RESISTANCE vs JUNCTION TEMPERATURE

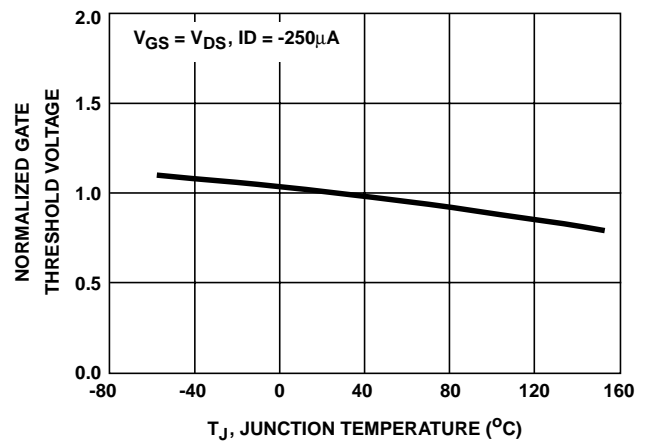

FIGURE 11. NORMALIZED GATE THRESHOLD VOLTAGE vs JUNCTION TEMPERATURE

Typical Performance Curves Unless Otherwise Specified (Continued)

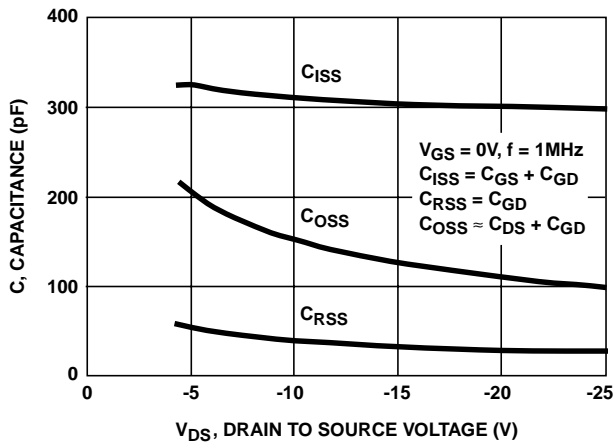
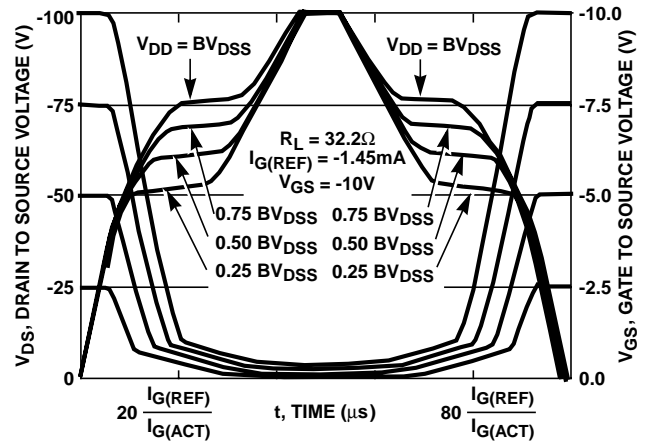

FIGURE 12. CAPACITANCE vs DRAIN TO SOURCE VOLTAGE



NOTE: Refer to Application Notes AN7254 and AN7260.  
FIGURE 13. NORMALIZED SWITCHING WAVEFORMS FOR CONSTANT GATE CURRENT

Test Circuits and Waveforms

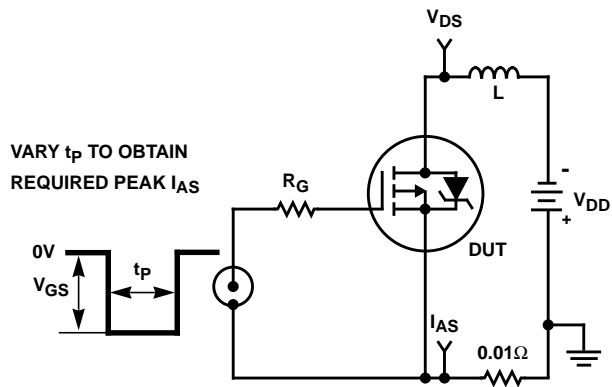

FIGURE 14. UNCLAMPED ENERGY TEST CIRCUIT

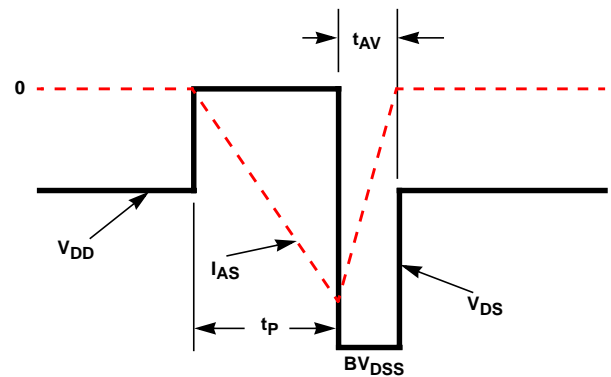

FIGURE 15. UNCLAMPED ENERGY WAVEFORMS

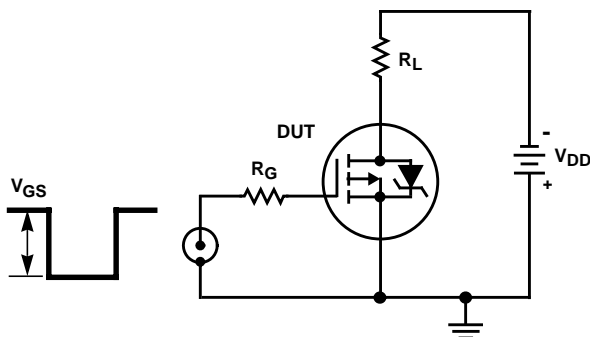

FIGURE 16. SWITCHING TIME TEST CIRCUIT

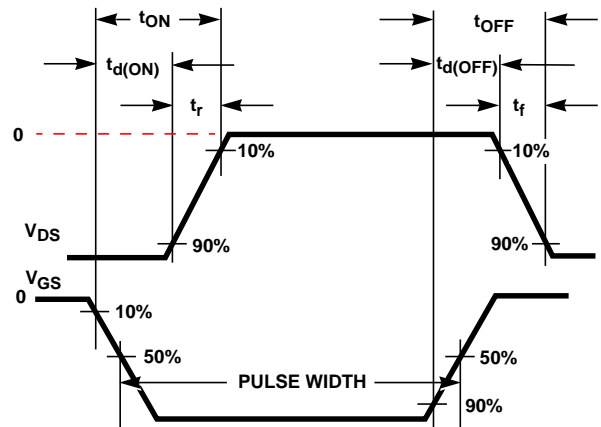

FIGURE 17. RESISTIVE SWITCHING WAVEFORMS

# IRFR9110, IRFU9110

## PSPICE Electrical Model

.SUBCKT IRFU9220 2 1 3 REV 9/6/94

CA 12 8 723e-12  
CB 15 14 733e-12  
CIN 6 8 517e-12

DBODY 5 7 DBDMOD  
DBREAK 5 11 DBKMOD  
DPLCAP 10 6 DPLCAPMOD

EBREAK 7 11 17 18 -244.4  
EDS 14 8 5 8 1  
EGS 13 8 6 8 1  
ESG 5 10 8 6 1  
EVTO 20 6 8 18 1

IT 8 17 1

LDRAIN 2 5 1e-9  
LGATE 1 9 2.609e-9  
LSOURCE 3 7 2.609e-9

MOS1 16 6 8 8 MOSMOD M=0.99  
MOS2 16 21 8 8 MOSMOD M=0.01

RBREAK 17 18 RBKMOD 1  
RDRAIN 50 16 RDSMOD 1.194  
RGATE 9 20 2.17  
RIN 6 8 1e9  
RLDRAIN 2 5 10  
RLGATE 1 9 26.09  
RLSOURCE 3 7 26.09  
RSCL1 5 51 RSCLMOD 1e-6  
RSCL2 5 50 1e3  
RSOURCE 8 7 RDSMOD 90.1e-3  
RVTO 18 19 RVTOMOD 1

S1A 6 12 13 8 S1AMOD  
S1B 13 12 13 8 S1BMOD  
S2A 6 15 14 13 S2AMOD  
S2B 13 15 14 13 S2BMOD

VBAT 8 19 DC 1  
VTO 21 6 -0.77

ESCL 51 50 VALUE={(V(5,51)/ABS(V(5,51)))\*(PWR(V(5,51))\*1e6/4.6,6)}

.MODEL DBDMOD D (IS=2.56e-14 RS=8.09e-2 TRS1=-2.45e-3 TRS2=-1.33e-5 CJO=4.21e-10 TT=1.17e-7)  
.MODEL DBKMOD D (RS=5.07 TRS1=-1.05e-3 TRS2=1.28e-5)  
.MODEL DPLCAPMOD D (CJO=170e-12 IS=1e-30 N=10)  
.MODEL MOSMOD PMOS (VTO=-3.58 KP=1.38 IS=1e-30 N=10 TOX=1 L=1u W=1u)  
.MODEL RBKMOD RES (TC1=1.1e-3 TC2=-2.73e-6)  
.MODEL RDSMOD RES (TC1=6.95e-3 TC2=2.23e-5)  
.MODEL RSCLMOD RES (TC1=2.40e-3 TC2=-1.5e-5)  
.MODEL RVTOMOD RES (TC1=-3.27e-3 TC2=-1.33e-6)  
.MODEL S1AMOD VSWITCH (RON=1e-5 ROFF=0.1 VON=5.29 VOFF=3.29)  
.MODEL S1BMOD VSWITCH (RON=1e-5 ROFF=0.1 VON=3.29 VOFF=5.29)  
.MODEL S2AMOD VSWITCH (RON=1e-5 ROFF=0.1 VON=0.1 VOFF=-4.9)  
.MODEL S2BMOD VSWITCH (RON=1e-5 ROFF=0.1 VON=-4.9 VOFF=0.1)

.ENDS

NOTE: For further discussion of the PSPICE model, consult **A New PSPICE Sub-Circuit for the Power MOSFET Featuring Global Temperature Options**; written by William J. Hepp and C. Frank Wheatley.

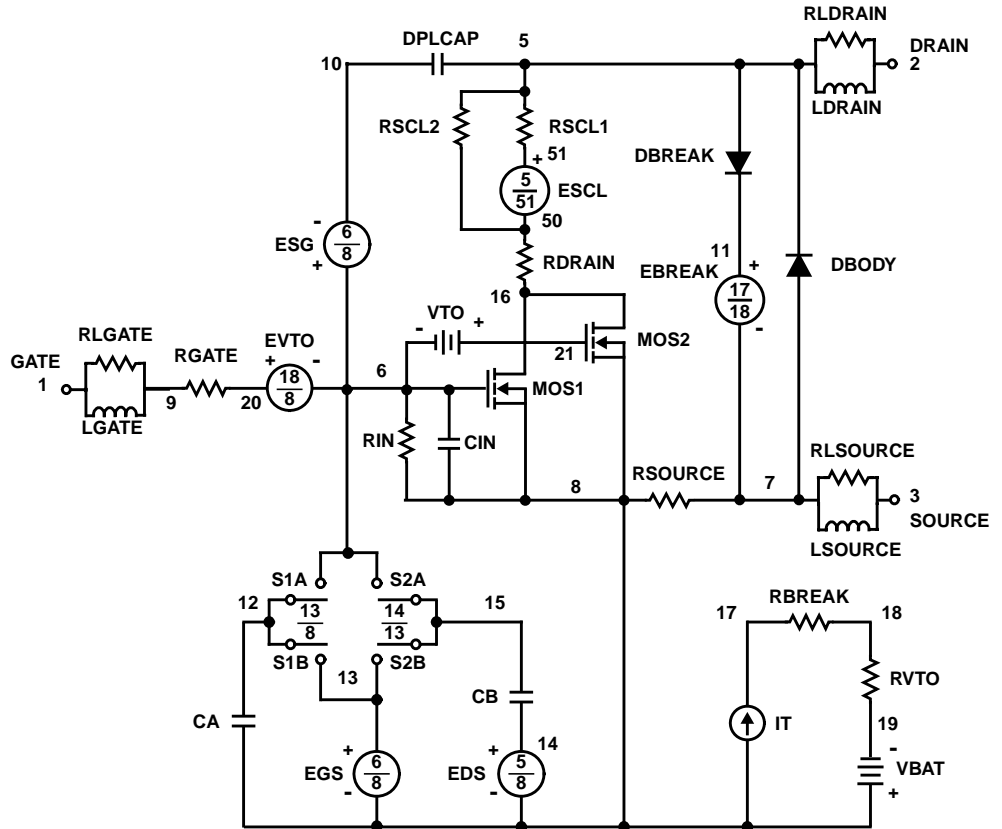

All Intersil semiconductor products are manufactured, assembled and tested under **ISO9000** quality systems certification.

*Intersil semiconductor products are sold by description only. Intersil Corporation reserves the right to make changes in circuit design and/or specifications at any time without notice. Accordingly, the reader is cautioned to verify that data sheets are current before placing orders. Information furnished by Intersil is believed to be accurate and reliable. However, no responsibility is assumed by Intersil or its subsidiaries for its use; nor for any infringements of patents or other rights of third parties which may result from its use. No license is granted by implication or otherwise under any patent or patent rights of Intersil or its subsidiaries.*

For information regarding Intersil Corporation and its products, see web site <http://www.intersil.com>

### **Sales Office Headquarters**

#### **NORTH AMERICA**

Intersil Corporation  
P. O. Box 883, Mail Stop 53-204  
Melbourne, FL 32902  
TEL: (407) 724-7000  
FAX: (407) 724-7240

#### **EUROPE**

Intersil SA  
Mercure Center  
100, Rue de la Fusee  
1130 Brussels, Belgium  
TEL: (32) 2.724.2111  
FAX: (32) 2.724.22.05

#### **ASIA**

Intersil (Taiwan) Ltd.  
7F-6, No. 101 Fu Hsing North Road  
Taipei, Taiwan  
Republic of China  
TEL: (886) 2 2716 9310  
FAX: (886) 2 2715 3029