

Low Cost Dual Power Distribution Controller

The HIP1013 is a low cost HOT SWAP dual supply power distribution controller. Two external N-Channel MOSFETs are driven to distribute power while providing load fault isolation. At turn-on, the gate of each external N-Channel MOSFET is charged with a 10µA current source. Capacitors on each gate (see the Typical Application Diagram), create a programmable ramp (soft turn-on) to control inrush currents. A built in charge pump supplies the gate drive for the 12V supply N-Channel MOSFET switch.

Over current protection is facilitated by two external current sense resistors. When the current through either resistor exceeds the user programmed value the N-Channel MOSFETs are latched off by the HIP1013. The controller is reset by a rising edge on either $\overline{\text{PWRON}}$ pin.

Choosing the voltage selection mode the HIP1013 controls either +12V/5V or +3.3V/+5V supplies.

Although pin compatible with the HIP1012 device, the HIP1013 does not offer current regulation during an OC event.

Ordering Information

PART NUMBER	TEMP. RANGE (°C)	PACKAGE	PKG. NO.
HIP1013CB	-0 to 70	14 Ld SOIC	M14.15
HIP1013CB-T	-0 to 70	14 Ld SOIC Tape and Reel	M14.15

Features

- HOT SWAP Dual Power Distribution Control for +5V and +12V or +5V and +3.3V
- Provides Fault Isolation
- Charge Pump Allows the Use of N-Channel MOSFETs
- Redundant Power On Controls
- Power Good and Over Current Latch Indicators
- Adjustable Turn-On Ramp
- Protection During Turn-On

Applications

- Power Distribution Control
- Hot Plug™ Components

Pinout

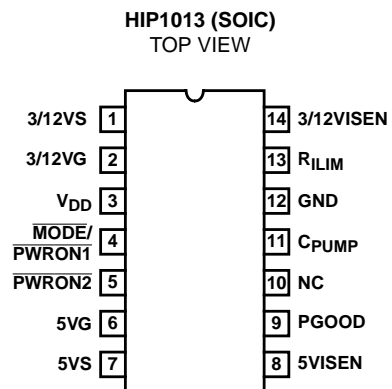

Typical Application Diagram

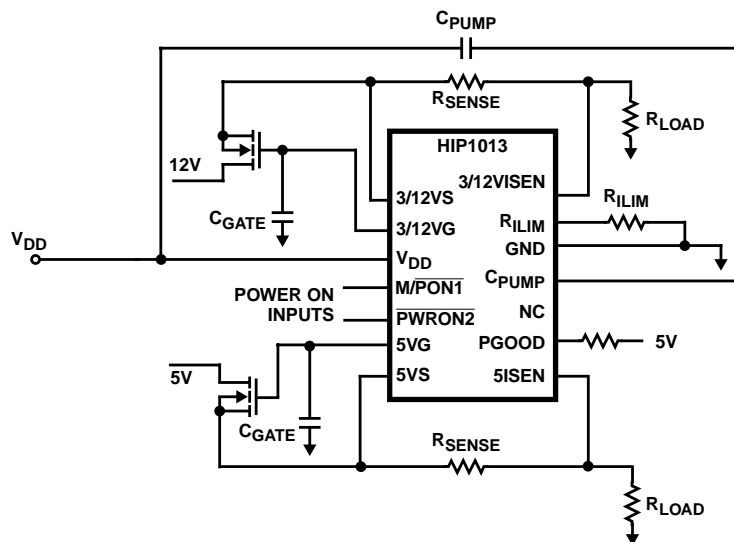

HIP1013

Pin Description

PIN NO.	SYMBOL	FUNCTION	DESCRIPTION
1	12VS	12V Source	Connect to source of associated external N-Channel MOSFET switch to sense output voltage.
2	12VG	12V Gate	Connect to the gate of associated N-Channel MOSFET switch. A capacitor from this node to ground sets the turn-on ramp. At turn-on this capacitor will be charged to $\approx 17.4V$ by a $10\mu A$ current source when in 5V/12V mode of operation, otherwise capacitor will be charged to $\approx 11.4V$.
3	V _{DD}	Chip Supply	Connect to 12V supply. This can be either connected directly to the +12V rail supplying the load voltage or to a dedicated V _{DD} +12V supply.
4	MODE/ PWRON1	Power ON/ Reset invokes 3.3V operation when shorted to V _{DD} , Pin 3.	PWRON1 and PWRON2 are used to turn-on and reset the chip. Both outputs turn-on when either pin is driven low. After an over current limit fault, the chip is reset by the rising edge of a reset signal applied to either PWRON pin. Each input has $100\mu A$ pull up capability which is compatible with 3V and 5V open drain and standard logic. PWRON1 is also used to invoke 3.3V control operation in preference to +12V control. By tying pin 4 to pin 3 the charge pump is disabled and the UV threshold also shifts to $\approx 2.8V$.
5	PWRON2	Power ON/Reset	
6	5VG	5V Gate	Connect to the gate of the external 5V N-Channel MOSFET. A capacitor from this node to ground sets the turn-on ramp. At turn-on this capacitor will be charged to $\approx 11.4V$ by a $10\mu A$ current source.
7	5VS	5V Source	Connect to the source side of 5V external N-Channel MOSFET switch to sense output voltage.
8	5VISEN	5V Current Sense	Connect to the load side of the 5V sense resistor to measure the voltage drop across this resistor between 5VS and 5VISEN pins.
9	PGOOD	Power Good Indicator	PGOOD is driven by an open drain N-Channel MOSFET. It is pulled low when either output voltage is not within specification or and OC condition exists.
10			No Connection.
11	CPUMP	Charge Pump Capacitor	Connect a $0.1\mu F$ capacitor between this pin and V _{DD} (Pin 3).
12	GND	Chip Ground	
13	R _{ILIM}	Current Limit Set Resistor	A resistor connected between this pin and ground determines the current level at which current limit is activated. This current is determined by the ratio of the R _{ILIM} resistor to the sense resistor (R _{SENSE}). The current at current limit onset is equal to $10\mu A \times (R_{ILIM}/R_{SENSE})$.
14	12VISEN	12V Current Sense	Connect to the load side of sense resistor to measure the voltage drop across this resistor.

HIP1013

Absolute Maximum Ratings $T_A = 25^\circ\text{C}$

V_{DD}	-0.3V to +13.2V
3/12VG, CPUMP	-0.3V to 18.5V
3/12VISEN, 3/12VS	-5V to $V_{DD} + 0.3V$
5VISEN, 5VS	-5V to 7.5V
PGOOD, R _{ILIM}	-0.3V to 7.5V
MODE/PWRON1, PWRON2, 5VG	-0.3V to $V_{DD} + 0.3V$
ESD Classification	2kV (Class 2)

Thermal Information

Thermal Resistance (Typical, Note 1)	θ_{JA} ($^\circ\text{C}/\text{W}$)
SOIC Package	120
Maximum Junction Temperature (Plastic Package)	150 $^\circ\text{C}$
Maximum Storage Temperature Range	-65 $^\circ\text{C}$ to 150 $^\circ\text{C}$
Maximum Lead Temperature (Soldering 10s)	300 $^\circ\text{C}$ (SOIC - Lead Tips Only)

Operating Conditions

V_{DD} Supply Voltage Range	+10.5V to +13.2V
Temperature Range (T_A)	0 $^\circ\text{C}$ to 70 $^\circ\text{C}$

CAUTION: Stresses above those listed in "Absolute Maximum Ratings" may cause permanent damage to the device. This is a stress only rating and operation of the device at these or any other conditions above those indicated in the operational sections of this specification is not implied.

NOTES:

- θ_{JA} is measured with the component mounted on an evaluation PC board in free air.
- All voltages are relative to GND, unless otherwise specified.

Electrical Specifications $V_{DD} = 12V$, $C_{VG} = 0.01\mu\text{F}$, $R_{SENSE} = 0.1\Omega$, $C_{BULK} = 220\mu\text{F}$, $ESR = 0.5\Omega$, $T_A = T_J = 0^\circ\text{C}$ to 70 $^\circ\text{C}$, Unless Otherwise Specified

PARAMETER	SYMBOL	TEST CONDITIONS	MIN	TYP	MAX	UNITS
CONTROL SECTION						
Current Limit Threshold Voltage (Voltage Across Sense Resistor)	V_{IL}	$R_{ILIM} = 10k\Omega$	85	100	115	mV
Over Current Limit Response Time	OC_{Lrt}	Current Overload, $R_{ILIM} = 10k\Omega$, $R_{SHORT} = 6.0\Omega$	-	2	-	μs
Response Time To Dead Short	RT_{SHORT}	$C_{VG} = 0.01\mu\text{F}$	-	500	1000	ns
12V Gate Turn-On Time	t_{ON12V}	$C_{VG} = 0.01\mu\text{F}$	-	12	-	ms
5V Gate Turn-On Time	t_{ON5V}	$C_{VG} = 0.01\mu\text{F}$	-	5	-	ms
Gate Turn-On Current	I_{ON}	$C_{VG} = 0.01\mu\text{F}$	8	10	12	μA
12V Under Voltage Threshold	12V _{VUV}		10.5	10.8	11.0	V
5V Under Voltage Threshold	5V _{VUV}		4.35	4.5	4.65	V
3.3V Under Voltage Threshold	3.3V _{VUV}		2.65	2.8	2.95	V
Charge pumped 12VG Voltage	V12VG	$C_{PUMP} = 0.1\mu\text{F}$	16.8	17.3	17.9	V
3/5VG High Voltage	3/5VG		11.2	11.9	-	V
SUPPLY CURRENT AND IO SPECIFICATIONS						
V_{DD} Supply Current	I_{VDD}		4	8	10	mA
V_{DD} POR Rising Threshold	POR_{rvth}		9.5	10.0	10.5	V
V_{DD} POR Falling Threshold	POR_{fvth}		9.3	9.8	10.3	V
\overline{PWRON} Pull-up Voltage	$PWRN_V$	\overline{PWRON} pins open	1.8	2.4	3.2	V
\overline{PWRON} Rising Threshold	PWR_Vth		1.1	1.5	2	V
\overline{PWRON} Hysteresis	PWR_hys		0.1	0.2	0.3	V
\overline{PWRON} Pull-Up Current	$PWRN_I$		60	80	100	μA
R_{ILIM} Pin Current Source Output	R_{ILIM_Io}		90	100	110	μA
Charge Pump Output Current	$Qpmp_Io$	$C_{PUMP} = 0.1\mu\text{F}$, $C_{PUMP} = 16V$	400	590	800	μA
Charge Pump Output Voltage	$Qpmp_Vo$	No load	17.2	17.4	-	V
Charge Pump Output Voltage - Loaded	$Qpmp_Vlo$	Load current = 100 μA	16.2	16.7	-	V
Charge Pump POR Rising Threshold	$Qpmp+Vth$		15.6	16	16.5	V
Charge Pump POR Falling Threshold	$Qpmp-Vth$		15.2	15.7	16.2	V

Typical Performance Curves

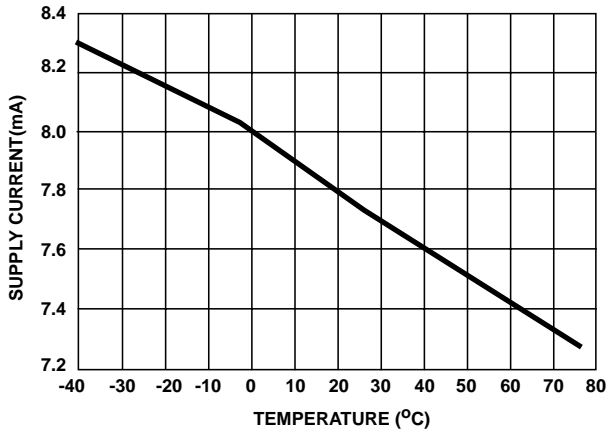

FIGURE 1. SUPPLY CURRENT

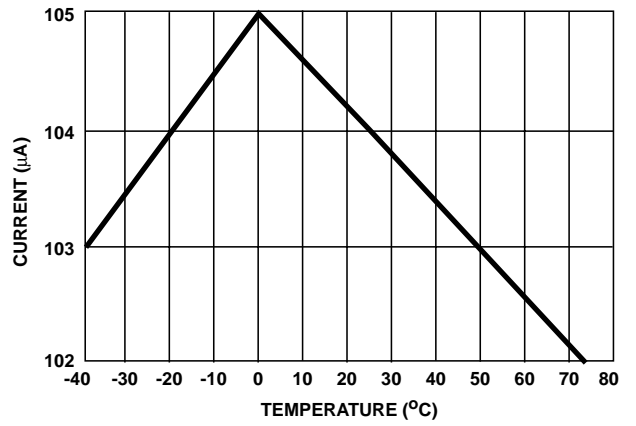

FIGURE 2. R_{ILIM} SOURCE CURRENT

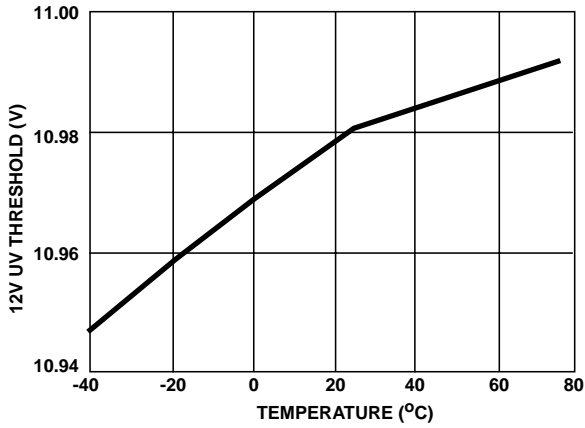

FIGURE 3. 12V UV THRESHOLD

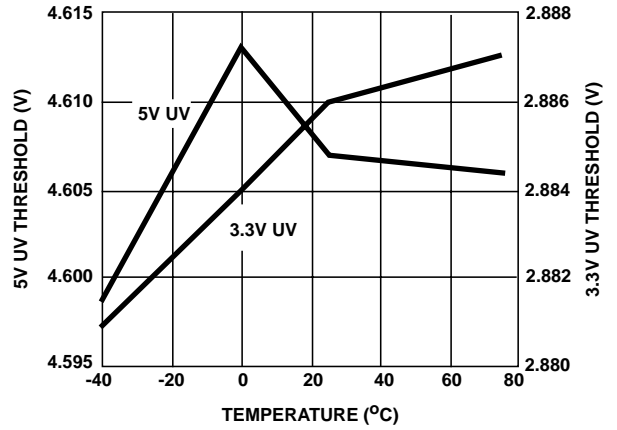

FIGURE 4. 3.3V/5V UV THRESHOLD

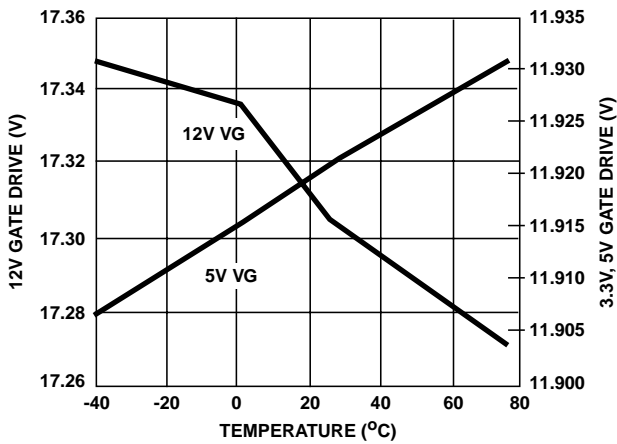

FIGURE 5. 12V, 5V GATE DRIVE

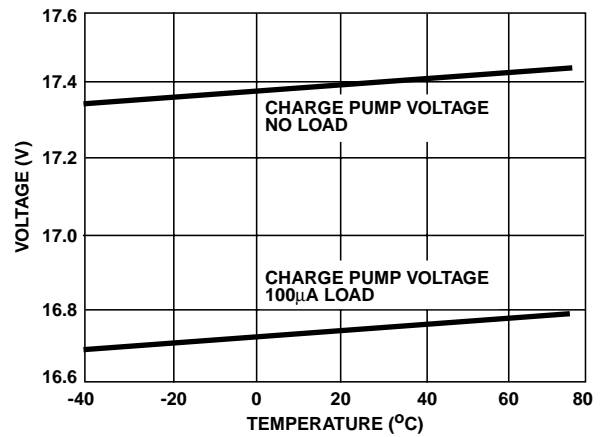

FIGURE 6. CHARGE PUMP VOLTAGE

Typical Performance Curves (Continued)

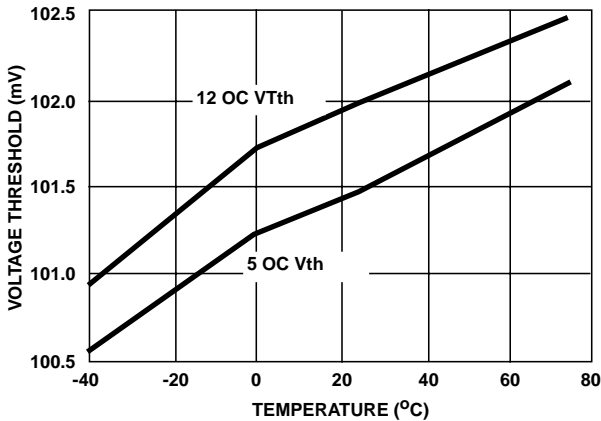

FIGURE 7. OC VOLTAGE THRESHOLD WITH $R_{ILIM} = 10k\Omega$

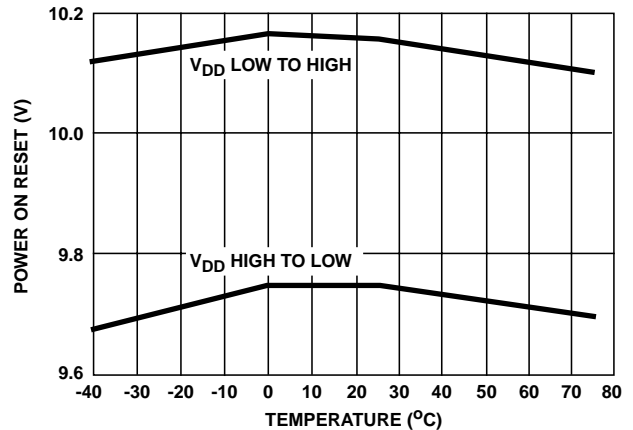

FIGURE 8. POWER ON RESET VOLTAGE THRESHOLD

HIP1013 Description and Operation

The HIP1013 offers the designer a cost efficient 5V and 12V true hot plug controller. This device drives two external N-Channel MOSFET switches and uses a charge pump to provide $\approx 17V$ to drive the gate of the 12V supply switch. The HIP1013 features Over Current (OC) programming with a single external resistor, R_{ILIM} and during turn-on, the gate capacitor of each external N-Channel MOSFET is charged with a $10\mu A$ current source. These capacitors create a programmable ramp (soft turn-on).

Upon initial power up, the HIP1013 can either isolate the voltage supply from the load by holding the external N-Channel MOSFET switches off or apply the supply rail voltage directly to the load for true hot swap capability. In either case the HIP1013 turns on in a soft start mode protecting the supply rail from sudden current loading.

The load currents pass through two external current sense resistors. When the voltage across either resistor exceeds the user programmed Over Current (OC) voltage threshold value, (see Table 1) the HIP1013 controller turns both N-Channel MOSFETs off in $\approx 2\mu s$.

TABLE 1.

R_{ILIM} RESISTOR	NOMINAL OC VTH
15K	150mV
10K	100mV
7.5K	75mV
4.99K	50mV

NOTE: Nominal OC Vth = $R_{ILIM} \times 10 \mu A$

The HIP1013 is reset by a rising edge on either \overline{PWRON} pin and is turned on by either \overline{PWRON} pin being driven low. The HIP1013 can control either +12V/5V or +3.3V/+5V supplies. Tying the $\overline{PWRON1}$ pin to V_{DD} , invokes the +3.3V/+5V voltage mode. In this mode, the external charge pump capacitor is not needed and C_{PUMP} , pin 11 is also tied

directly to V_{DD} . Upon any OC or Under Voltage (UV) condition the PGOOD fault indicating signal will pull low when tied high through a resistor to the logic supply.

HIP1013 Application Considerations

There is no unique and specific HIP1013 application evaluation board. Since the HIP1013 is pin compatible with the HIP1012 device, you can substitute a HIP1013 for the existing HIP1012 in either of the HIP1012EVAL1 or EVAL2 boards. Otherwise contact your Intersil Corporation sales office and an already modified board will be provided. Although pin compatible to the HIP1012, the HIP1013 is a less featured dual power supply distribution controller and does not include programmable current limiting regulation and delay time to latch off.

Random resets can also occur if the HIP1013 (PINS 8 and 14) sense pins are pulled below ground when turning off a highly inductive load. Place a large load capacitor (10-50 μF) on the output to eliminate unintended resets.

Physical layout of R_{SENSE} resistors is critical to avoid the possibility of false over current occurrences. Ideally trace routing between the R_{SENSE} resistors and the HIP1013 VS and VISEN pins are direct and as short as possible with zero current in the sense lines.

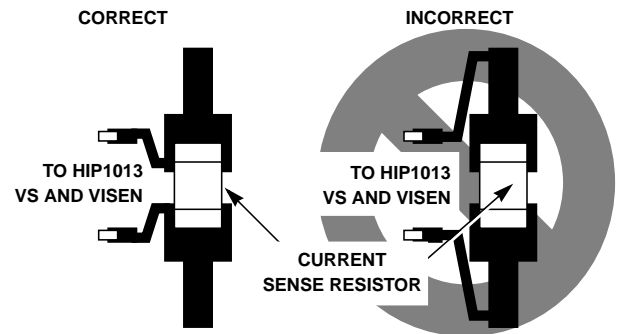

All Intersil semiconductor products are manufactured, assembled and tested under **ISO9000** quality systems certification.

Intersil semiconductor products are sold by description only. Intersil Corporation reserves the right to make changes in circuit design and/or specifications at any time without notice. Accordingly, the reader is cautioned to verify that data sheets are current before placing orders. Information furnished by Intersil is believed to be accurate and reliable. However, no responsibility is assumed by Intersil or its subsidiaries for its use; nor for any infringements of patents or other rights of third parties which may result from its use. No license is granted by implication or otherwise under any patent or patent rights of Intersil or its subsidiaries.

For information regarding Intersil Corporation and its products, see web site <http://www.intersil.com>

Sales Office Headquarters

NORTH AMERICA

Intersil Corporation
P. O. Box 883, Mail Stop 53-204
Melbourne, FL 32902
TEL: (407) 724-7000
FAX: (407) 724-7240

EUROPE

Intersil SA
Mercure Center
100, Rue de la Fusee
1130 Brussels, Belgium
TEL: (32) 2.724.2111
FAX: (32) 2.724.22.05

ASIA

Intersil (Taiwan) Ltd.
7F-6, No. 101 Fu Hsing North Road
Taipei, Taiwan
Republic of China
TEL: (886) 2 2716 9310
FAX: (886) 2 2715 3029