

2SA1492

Silicon PNP Epitaxial Planar Transistor (Complement to type 2SC3856)

Application : Audio and General Purpose

Absolute maximum ratings (Ta=25°C)

Symbol	2SA1492	Unit
V _{CB0}	-180	V
V _{CE0}	-180	V
V _{EBO}	-6	V
I _c	-15	A
I _B	-4	A
P _c	130(T _C =25°C)	W
T _j	150	°C
T _{stg}	-55 to +150	°C

Electrical Characteristics (Ta=25°C)

Symbol	Conditions	2SA1492	Unit
I _{CB0}	V _{CB} =-180V	-100max	μA
I _{EBO}	V _{EB} =-6V	-100max	μA
V(BR) _{CEO}	I _c =-50mA	-180min	V
h _{FE}	V _{CE} =-4V, I _c =-3A	50min*	
V _{CE(sat)}	I _c =-5A, I _B =-0.5A	-2.0max	V
f _T	V _{CE} =-12V, I _E =0.5A	20typ	MHz
C _{OB}	V _{CB} =-10V, f=1MHz	500typ	pF

*h_{FE} Rank O(50 to 100), P(70 to 140), Y(90 to 180)

Typical Switching Characteristics (Common Emitter)

V _{CC} (V)	R _L (Ω)	I _c (A)	V _{BB1} (V)	V _{BB2} (V)	I _{B1} (A)	I _{B2} (A)	t _{on} (μs)	t _{stg} (μs)	t _f (μs)
-40	4	-10	-10	5	-1	1	0.6typ	0.9typ	0.2typ

External Dimensions MT-100(TO3P)

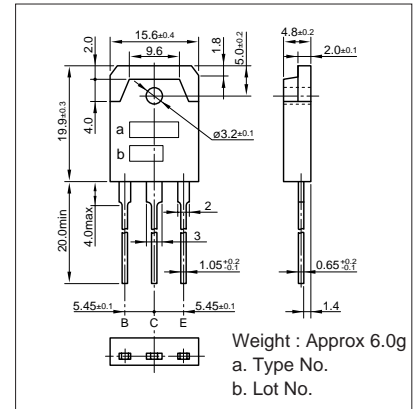

I_c-V_{CE} Characteristics (Typical)

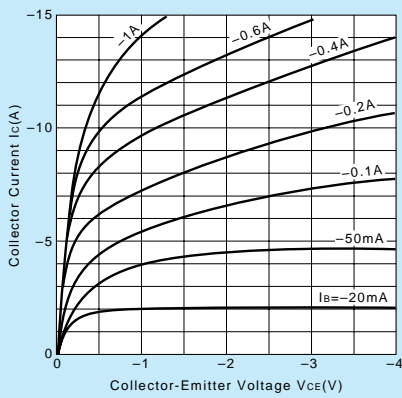

V_{CE(sat)}-I_B Characteristics (Typical)

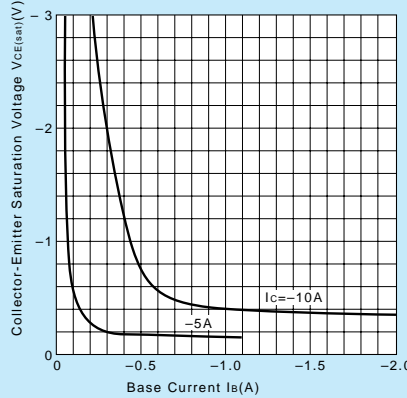

I_c-V_{BE} Temperature Characteristics (Typical)

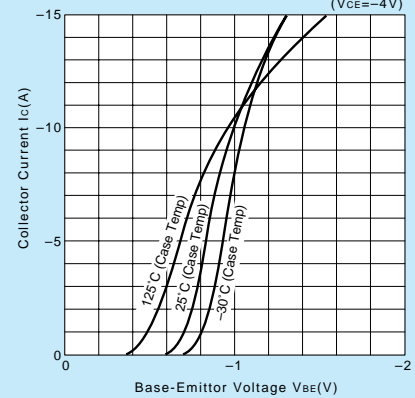

h_{FE}-I_c Characteristics (Typical)

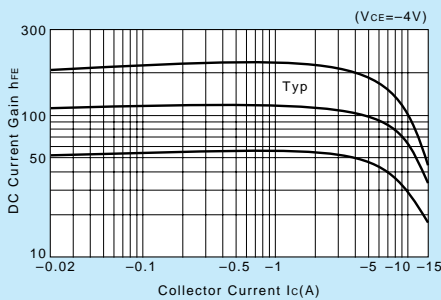

h_{FE}-I_c Temperature Characteristics (Typical)

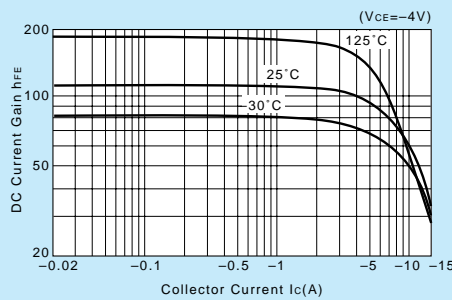

θ_{J-a}-t Characteristics

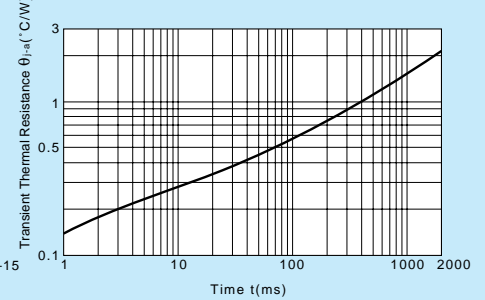

f_T-I_E Characteristics (Typical)

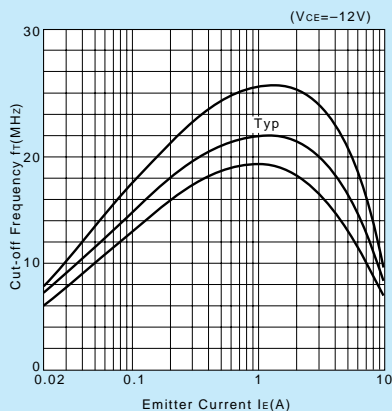

Safe Operating Area (Single Pulse)

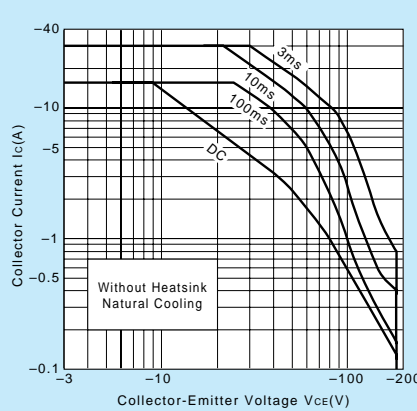

P_c-T_a Derating

